

ANNEX 8

**RESOLUTION MSC.426(98)
(adopted on 15 June 2017)**

**AMENDMENTS TO THE INTERNATIONAL MARITIME
SOLID BULK CARGOES (IMSBC) CODE**

THE MARITIME SAFETY COMMITTEE,

RECALLING Article 28(b) of the Convention on the International Maritime Organization concerning the functions of the Committee,

NOTING resolution MSC.268(85) by which it adopted the International Maritime Solid Bulk Cargoes Code ("the IMSBC Code"), which has become mandatory under chapter VI of the International Convention for the Safety of Life at Sea, 1974, as amended ("the Convention"),

NOTING ALSO article VIII(b) and regulation VI/1-1.1 of the Convention concerning the procedure for amending the IMSBC Code,

HAVING CONSIDERED, at its ninety-eighth session, amendments to the IMSBC Code, proposed and circulated in accordance with article VIII(b)(i) of the Convention,

1 ADOPTS, in accordance with article VIII(b)(iv) of the Convention, amendments to the IMSBC Code, the text of which is set out in the annex to the present resolution;

2 DETERMINES, in accordance with article VIII(b)(vi)(2)(bb) of the Convention, that said amendments shall be deemed to have been accepted on 1 July 2018 unless, prior to that date, more than one third of the Contracting Governments to the Convention or Contracting Governments the combined merchant fleets of which constitute not less than 50% of the gross tonnage of the world's merchant fleet, have notified the Secretary-General of their objections to the amendments;

3 INVITES Contracting Governments to the Convention to note that, in accordance with article VIII(b)(vii)(2) of the Convention, the amendments shall enter into force on 1 January 2019 upon their acceptance in accordance with paragraph 2 above;

4 AGREES that Contracting Governments to the Convention may apply the aforementioned amendments in whole or in part on a voluntary basis as from 1 January 2018;

5 REQUESTS the Secretary-General, for the purpose of article VIII(b)(v) of the Convention, to transmit certified copies of the present resolution and the text of the amendments contained in the annex to all Contracting Governments to the Convention; and

6 FURTHER REQUESTS the Secretary-General to transmit copies of this resolution and its annex to Members of the Organization which are not Contracting Governments to the Convention.

ANNEX

AMENDMENTS TO THE INTERNATIONAL MARITIME SOLID BULK CARGOES (IMSBC) CODE

Section 1 General provisions

1.4 Application and implementation of this Code

1 In paragraph 1.4.2, the words "Characteristics (other than CLASS and GROUP)" are replaced with the words "Characteristics (other than CLASS, SUBSIDIARY RISK and GROUP)". The words "Paragraph 4.2.2.2;" and "Section 14 Prevention of pollution by cargo residues from ships;" are deleted.

1.7 Definitions

2 In the definition for "*Bulk Cargo Shipping Name (BCSN)*", the third sentence is replaced with the following:

"When a cargo is dangerous goods as defined in the IMDG Code, as defined in regulation VII/1.1 of the SOLAS Convention, refer to 4.1.1."

Section 4 Assessment of acceptability of consignments for safe shipment

4.1 Identification and classification

3 The existing paragraph "4.1.1" is replaced with the following:

"4.1.1 Bulk Cargo Shipping Name

4.1.1.1 Each solid bulk cargo in this Code has been assigned a Bulk Cargo Shipping Name (BCSN). When a solid bulk cargo is carried by sea it shall be identified in the transport documentation by the BCSN.

4.1.1.2 Where the cargo is dangerous goods and not identified with a generic Proper Shipping Name, or not otherwise specified (N.O.S) in the IMDG Code, the BCSN shall consist of the Proper Shipping Name followed by the UN number.

4.1.1.3 Except for RADIOACTIVE MATERIAL, LOW SPECIFIC ACTIVITY (LSA-I), non-fissile or fissile – excepted UN 2912 and RADIOACTIVE MATERIAL, SURFACE CONTAMINATED OBJECTS (SCO-I), non-fissile or fissile – excepted UN 2913, where the cargo is dangerous goods identified with a generic Proper Shipping Name and/or not otherwise specified (N.O.S) in the IMDG Code, the BCSN shall consist of, in the following order:

- .1 a chemical or technical name of the material;
- .2 a specific description to identify the properties of the material; and
- .3 the UN number."

4.2 Provision of information

4 The existing paragraph 4.2.2.1 is renumbered as "4.2.2".

5 In the renumbered paragraph 4.2.2, in sub-paragraph .15, the word "and" is deleted.

6 In the renumbered paragraph 4.2.2, a new sub-paragraph .16 is inserted as follows:

.16 whether or not the cargo is classified as harmful to the marine environment in accordance with Annex V of the International Convention for the Prevention of Pollution from Ships, 1973, as modified by the Protocol of 1978 relating thereto, as amended; and"

7 In the renumbered paragraph 4.2.2, the existing sub-paragraph .16 is renumbered as sub-paragraph .17.

8 Paragraph 4.2.2.2 "The cargo information should include whether or not the cargo is harmful to the marine environment*" and the corresponding footnote are deleted.

4.5 Interval between sampling/testing and loading for TML and moisture content determination

9 Replace the existing paragraphs 4.5.1 and 4.5.2 with the following:

"4.5.1 The shipper shall be responsible for ensuring that a test to determine the TML of a solid bulk cargo is conducted within six months to the date of loading the cargo. Notwithstanding this provision, where the composition or characteristics of the cargo are variable for any reason, the shipper shall be responsible for ensuring that a test to determine the TML is conducted again after it is reasonably assumed that such variation has taken place.

4.5.2 The shipper shall be responsible for ensuring that sampling and testing for moisture content is conducted as near as practicable to the date of commencement of loading. The interval between sampling/testing and the date of commencement of loading shall never be more than seven days. If the cargo has been exposed to significant rain or snow between the time of testing and the date of completion of loading, the shipper shall be responsible for ensuring that the moisture content of the cargo is still less than its TML, and evidence of this is provided to the master as soon as practicable."

Section 9

Materials possessing chemical hazards

9.3.3 Segregation between bulk materials possessing chemical hazards and dangerous goods in packaged form

10 In the segregation table as contained in paragraph 9.3.3, in the row of "Substances which, in contact with water, emit flammable gases", under the column "2.1", replace the number "1" with "2".

Section 13
References to related information and recommendations

13.2 Reference list

11 In section 13.2.7 "Minimum information/documentation", new rows are added at the end of section as follows:

4.2	MARPOL Annex V, regulation 4.3	<i>Discharge of garbage outside special areas</i>
4.2	MARPOL Annex V, regulation 6.1.2.2	<i>Discharge of garbage within special areas</i>

13.2.10 Segregation

12 Delete row "9.3.3".

13.2.11 Transport of solid wastes in bulk

13 In row "10.6", under the column "Reference to the relevant IMO instruments or standard (2)", replace the term "chapter 7.8.4" with "sub-section 2.0.5.4".

Section 14
Prevention of pollution by cargo residues from ships

14 Section 14 is deleted.

APPENDIX 1

Individual schedules of solid bulk cargoes

Amendments to existing individual schedules

ALUMINA

15 In the individual schedule for "ALUMINA", under the section for "Loading", replace the words "of the Code" with the words "of this Code".

ALUMINA, CALCINED

16 In the individual schedule for "ALUMINA, CALCINED", under the section for "Loading", replace the words "of the Code" with the words "of this Code".

ALUMINA HYDRATE

17 In the individual schedule for "ALUMINA HYDRATE", under the section for "Hazard", in the first sentence, add the word "a" before "moisture content"; in the second sentence, replace the words "of the Code" with the words "of this Code" and under the section for "Loading", replace the words "of the Code" with the words "of this Code".

ALUMINA SILICA

18 In the individual schedule for "ALUMINA SILICA", under the section for "Loading", replace the words "of the Code" with the words "of this Code".

ALUMINA SILICA, pellets

19 In the individual schedule for "ALUMINA SILICA, pellets", under the section for "Loading", replace the words "of the Code" with the words "of this Code".

ALUMINIUM FERROSILICON POWDER UN 1395

20 In the individual schedule for "ALUMINIUM FERROSILICON POWDER UN 1395", under the section for "Loading", replace the words "of the Code" with the words "of this Code".

ALUMINIUM FLUORIDE

21 In the individual schedule for "ALUMINIUM FLUORIDE", under the section for "Weather precautions", the words "less than its TML during voyage" are replaced with the words "less than its TML during loading operations and the voyage".

ALUMINIUM NITRATE UN 1438

22 In the individual schedule for "ALUMINIUM NITRATE UN 1438", under the section for "Loading", replace the words "of the Code" with the words "of this Code".

ALUMINIUM SILICON POWDER, UNCOATED UN 1398

23 In the individual schedule for "ALUMINIUM SILICON POWDER, UNCOATED UN 1398", under the section for "Loading", replace the words "of the Code" with the words "of this Code".

ALUMINIUM SMELTING BY-PRODUCTS or ALUMINIUM REMELTING BY-PRODUCTS UN 3170

24 In the individual schedule for "ALUMINIUM SMELTING BY-PRODUCTS or ALUMINIUM REMELTING BY-PRODUCTS UN 3170", under the section for "Loading", replace the words "of the Code" with the words "of this Code".

ALUMINIUM SMELTING/REMELTING BY-PRODUCTS, PROCESSED

25 In the individual schedule for "ALUMINIUM SMELTING/REMELTING BY-PRODUCTS, PROCESSED", under the section for "Hazard", in the second sentence, add the word "a" before "moisture content"; in the third sentence, replace the words "of the Code" with the words "of this Code". Under the section for "Loading", replace the words "of the Code" with the words "of this Code". Under the section for "Clean-up", in the third sentence, replace the word "should" with "shall".

AMMONIUM NITRATE UN 1942

26 In the individual schedule for "AMMONIUM NITRATE UN 1942", under the section for "Loading", in the second sentence, replace the words "under sections 4, 5 and 6 of the Code" with the words "under sections 4 and 5 of this Code".

AMMONIUM NITRATE BASED FERTILIZER UN 2067

27 In the individual schedule for "AMMONIUM NITRATE BASED FERTILIZER UN 2067", under the section for "Loading", in the first sentence, replace the words "under sections 4, 5 and 6 of the Code" with the words "under sections 4 and 5 of this Code".

AMMONIUM NITRATE BASED FERTILIZER UN 2071

28 In the individual schedule for "AMMONIUM NITRATE BASED FERTILIZER UN 2071", under the section for "Loading", in the first sentence, replace the words "under sections 4, 5 and 6 of the Code" with the words "under sections 4 and 5 of this Code".

AMMONIUM NITRATE BASED FERTILIZER (non-hazardous)

29 In the individual schedule for "AMMONIUM NITRATE BASED FERTILIZER (non-hazardous)", under the section for "Stowage and segregation", in the first sentence, replace the word "should" with "shall". Under the section for "Loading", in the first sentence, replace the words "under sections 4, 5 and 6 of the Code" with the words "under sections 4 and 5 of this Code".

AMMONIUM SULPHATE

30 In the individual schedule for "AMMONIUM SULPHATE", under the section for "Loading", in the third sentence, replace the words "under sections 4, 5 and 6 of the Code" with the words "under sections 4 and 5 of this Code".

ANTIMONY ORE AND RESIDUE

31 In the individual schedule for "ANTIMONY ORE AND RESIDUE", under the section for "Loading", in the first sentence, replace the words "of the Code" with the words "of this Code".

BARIUM NITRATE UN 1446

32 In the individual schedule for "BARIUM NITRATE UN 1446", under the section for "Loading", replace the words "of the Code" with the words "of this Code".

BARYTES

33 In the individual schedule for "BARYTES", under the section for "Loading", in the first sentence, replace the words "of the Code" with the words "of this Code".

BAUXITE

34 In the individual schedule for "BAUXITE", under the section for "Loading", replace the words "of the Code" with the words "of this Code".

BIOSLUDGE

35 In the individual schedule for "BIOSLUDGE", under the section for "Loading", replace the words "of the Code" with the words "of this Code".

BORAX (PENTAHYDRATE CRUDE)

36 In the individual schedule for "BORAX (PENTAHYDRATE CRUDE)", under the section for "Loading", replace the words "of the Code" with the words "of this Code".

BORAX, ANHYDROUS (crude or refined)

37 In the individual schedule for "BORAX, ANHYDROUS (crude or refined)", under the section for "Loading", replace the words "under sections 4, 5 and 6 of the Code" with the words "under sections 4 and 5 of this Code".

BROWN COAL BRIQUETTES

38 In the individual schedule for "BROWN COAL BRIQUETTES", in the appendix of the schedule, under the section for "Carriage", in 8.1, after the words "The company's", add "*" with the following footnote:

* Refer to SOLAS regulation IX/1.2.;

and under the section for "Discharge", after the words "self-contained breathing apparatus", add "*" with the following footnote:

* Refer to the *Revised recommendations for entering enclosed spaces aboard ships*, adopted by the Organization by resolution A.1050(27)."

CALCIUM NITRATE UN 1454

39 In the individual schedule for "CALCIUM NITRATE UN 1454", under the section for "Loading", in the second sentence, replace the words "of the Code" with the words "of this Code".

CALCIUM NITRATE FERTILIZER

40 In the individual schedule for "CALCIUM NITRATE FERTILIZER", under the section for "Loading", replace the words "under sections 4, 5 and 6 of the Code" with the words "under sections 4 and 5 of this Code".

CARBORUNDUM

41 In the individual schedule for "CARBORUNDUM", under the section for "Loading", replace the words "of the Code" with the words "of this Code" and add the following text:

"As the density of the cargo is extremely high, the tank top may be overstressed unless the cargo is evenly spread across the tank top to equalize the weight distribution. Due consideration shall be paid to ensure that the tank top is not overstressed during voyage and during loading by a pile of the cargo.";

and under the section for "Precautions", replace the word "should" with the word "shall".

CASTOR BEANS or CASTOR MEAL or CASTOR POMACE or CASTOR FLAKE UN 2969

42 In the individual schedule for "CASTOR BEANS or CASTOR MEAL or CASTOR POMACE or CASTOR FLAKE UN 2969", under the section for "Loading", replace the words "of the Code" with the words "of this Code".

CEMENT CLINKERS

43 In the individual schedule for "CEMENT CLINKERS", under the section for "Loading", replace the words "of the Code" with the words "of this Code".

CHAMOTTE

44 In the individual schedule for "CHAMOTTE", under the section for "Loading", replace the words "of the Code" with the words "of this Code".

CHARCOAL

45 In the individual schedule for "CHARCOAL", under the section for "Loading", in the first sentence, replace the words "of the Code" with the words "of this Code".

CHOPPED RUBBER AND PLASTIC INSULATION

46 In the individual schedule for "CHOPPED RUBBER AND PLASTIC INSULATION", under the section for "Loading", replace the words "of the Code" with the words "of this Code".

CHROME PELLETS

47 In the individual schedule for "CHROME PELLETS", under the section for "Loading", replace the words "of the Code" with the words "of this Code".

CHROMITE ORE

48 In the individual schedule for "CHROMITE ORE ", under the section for "Loading", in the first sentence, replace the words "of the Code" with the words "of this Code".

CLAY

49 In the individual schedule for "CLAY", under the section for "Loading", replace the words "of the Code" with the words "of this Code".

CLINKER ASH

50 In the existing individual schedule for "CLINKER ASH", under the section for "Description", in the fourth sentence, the words "taken out" are replaced with "discharged" twice. Under the section for "Hazard", in the second sentence, replace the words "of the Code" with the words "of this Code". Under the section for "Loading", replace the words "of the Code" with the words "of this Code".

COAL

51 In the individual schedule for "COAL", under the BCSN, add the following sentences and the corresponding footnote:

"Coal shall be classified as Group A and B unless classified as Group B only by a test determined by the appropriate authority* or where it has the following particle size distribution:

- .1 not more than 10% by weight of particles less than 1 mm (D10 > 1mm); and

- .2 not more than 50% by weight of particles less than 10 mm (D50 > 10 mm).

Notwithstanding the above, a blend of two or more coals shall be classified as Group A and B unless all original coals in the blend are Group B only.

* See subsection 8.1 of this Code."

52 Under the section for "Hazard", delete the sentence "Can liquefy if predominantly fine 75% less than 5 mm coal." and add the sentence "This cargo may liquefy if shipped at a moisture content in excess of its transportable moisture limit (TML). See sections 7 and 8 of this Code." at the end of the section.

53 Under the section for "Weather precautions", replace paragraphs .1 and .4 with the following sentences, respectively:

".1 the moisture content of the cargo shall be kept less than its TML during loading operations and the voyage;"

and

".4 the cargo may be handled during precipitation under the conditions stated in the procedures required in paragraph 4.3.3 of this Code; and";

and under the section for "Loading", in the first sentence, replace the words "of the Code" with the words "of this Code". and add the sentence "Due consideration shall be given to moisture migration and formation of dangerous wet base when blended coals are loaded." at the end of the section.

54 In the appendix, under the section "Special precautions", in "2 Self-heating coals", in paragraph .5, after the words "and the company", add "*" with the following footnote:

"* Refer to SOLAS regulation IX/1.2."

COAL SLURRY

55 In the individual schedule for "COAL SLURRY", under the section for "Hazard", replace the first sentence with:

"This cargo may liquefy if shipped at a moisture content in excess of its transportable moisture limit (TML). See sections 7 and 8 of this Code.";

under the section for "Weather precautions", replace paragraphs .1 and .4 with the following sentences, respectively:

".1 the moisture content of the cargo shall be kept less than its TML during loading operations and the voyage;"

and

".4 the cargo may be handled during precipitation under the conditions stated in the procedures required in paragraph 4.3.3 of this Code; and";

and under the section for "Loading", replace the words "of the Code" with the words "of this Code".

COAL TAR PITCH

56 In the individual schedule for "COAL TAR PITCH", under the section for "Loading", replace the words "of the Code" with the words "of this Code".

COARSE CHOPPED TYRES

57 In the individual schedule for "COARSE CHOPPED TYRES", under the section for "Loading", replace the words "of the Code" with the words "of this Code".

COARSE IRON AND STEEL SLAG AND ITS MIXTURE

58 In the individual schedule for "COARSE IRON AND STEEL SLAG AND ITS MIXTURE", under the section for "Loading", in the first sentence, replace the words "of the Code" with the words "of this Code".

COKE

59 In the individual schedule for "COKE", under the section for "Loading", replace the words "of the Code" with the words "of this Code".

COKE BREEZE

60 In the individual schedule for "COKE BREEZE", under the section for "Hazard", replace the first sentence with:

"This cargo may liquefy if shipped at a moisture content in excess of its transportable moisture limit (TML). See sections 7 and 8 of this Code.";

under the section for "Weather precautions", replace paragraphs .1 and .4 with the following sentences, respectively:

".1 the moisture content of the cargo shall be kept less than its TML during loading operations and the voyage;"

and

".4 the cargo may be handled during precipitation under the conditions stated in the procedures required in paragraph 4.3.3 of this Code; and";

and under the section for "Loading", replace the words "of the Code" with the words "of this Code".

COLEMANITE

61 In the individual schedule for "COLEMANITE", under the section for "Loading", replace the words "of the Code" with the words "of this Code".

COPPER GRANULES

62 In the individual schedule for "COPPER GRANULES", under the section for "Loading", in the first sentence, replace the words "of the Code" with the words "of this Code".

COPPER MATTE

63 In the individual schedule for "COPPER MATTE", under the section for "Loading", in the first sentence, replace the words "of the Code" with the words "of this Code".

COPPER SLAG

64 In the individual schedule for "COPPER SLAG ", under the section for "Hazard", in the first sentence, add the word "a" before the words "moisture content". Under the section for "Loading", replace the first sentence with the following:

"This cargo shall be trimmed to ensure that the height difference between peaks and troughs does not exceed 5% of the ship's breadth and that the cargo slopes uniformly from the hatch boundaries to the bulkheads to avoid steep surfaces of cargo that could collapse during voyage.";

and under the section for "Carriage", add the following text at the end of the section:

"The appearance of the surface of this cargo shall be checked regularly during voyage. If free water above the cargo or fluid state of the cargo is observed during voyage, the master shall take appropriate actions to prevent cargo shifting and potential capsize of the ship, and give consideration to seeking emergency entry into a place of refuge."

COPRA (dry) UN 1363

65 In the individual schedule for "COPRA (dry) UN 1363", under the section for "Loading", in the first sentence, replace the words "of the Code" with the words "of this Code". Under the section for "Precautions", after the words "concentration of oxygen", add "*" with the following footnote:

* Refer to the *Revised recommendations for entering enclosed spaces aboard ships*, adopted by the Organization by resolution A.1050(27)."

CRUSHED CARBON ANODES

66 In the individual schedule for "CRUSHED CARBON ANODES", under the section for "Loading", replace the words "of the Code" with the words "of this Code".

CRYOLITE

67 In the individual schedule for "CRYOLITE", under the section for "Loading", replace the words "of the Code" with the words "of this Code".

DIAMMONIUM PHOSPHATE (D.A.P.)

68 In the individual schedule for "DIAMMONIUM PHOSPHATE (D.A.P.)", under the section for "Loading", replace the words "under sections 4, 5 and 6 of the Code" with the words "under sections 4 and 5 of this Code".

DIRECT REDUCED IRON (A) Briquettes, hot-moulded

69 In the individual schedule for "DIRECT REDUCED IRON (A) Briquettes, hot-moulded", under the section for "Loading", in the sixth sentence, replace the words "of the Code" with the words "of this Code"; add the following text at the end of the section:

"As the density of the cargo is extremely high, the tank top may be overstressed unless the cargo is evenly spread across the tank top to equalize the weight distribution. Due consideration shall be paid to ensure that the tank top is not overstressed during voyage and during loading by a pile of the cargo.";

under the section for "Precautions", in the last sentence, after the words "adjacent spaces", add "*" with the following footnote:

* Refer to the *Revised recommendations for entering enclosed spaces aboard ships*, adopted by the Organization by resolution A.1050(27).";

and under the sections for "Carriage" and "Discharge", replace the words "(> 25% LEL)" with "(> 25% lower explosive limit (LEL))". Under the section for "Clean-up", in the third sentence, replace the word "should" with the word "shall".

DIRECT REDUCED IRON (B) Lumps, pellets, cold-moulded briquettes

70 In the individual schedule for "DIRECT REDUCED IRON (B) Lumps, pellets, cold-moulded briquettes", under the section for "Loading", in the sentence "Trim in accordance with the relevant provisions required under sections 4 and 5 of the Code", replace the words "of the Code" with the words "of this Code"; add the following text:

"When the stowage factor of this cargo is equal to or less than 0.56 m³/t, the tank top may be overstressed unless the cargo is evenly spread across the tank top to equalize the weight distribution. Due consideration shall be given to ensure that the tank top is not overstressed during the voyage and during loading by a pile of the cargo.";

under the section for "Precautions", in the sentence "All precautions shall be taken when entering the cargo spaces", after the words "entering the cargo spaces", add "*" with the following footnote:

* Refer to the *Revised recommendations for entering enclosed spaces aboard ships*, adopted by the Organization by resolution A.1050(27).";

and under the sections for "Carriage" and "Discharge", replace the words "(> 25% LEL)" with "(> 25% lower explosive limit (LEL))". Under the section for "Clean-up", in the second sentence, replace the word "should" with the word "shall".

DIRECT REDUCED IRON (C) By-product fines

71 In the individual schedule for "DIRECT REDUCED IRON (C) (By-product fines)", under the section for "Loading", in the sentence "Trim in accordance with the relevant provisions required under sections 4 and 5 of the Code", replace the words "of the Code" with the words "of this Code"; and add the following text:

"As the density of the cargo is extremely high, the tank top may be overstressed unless the cargo is evenly spread across the tank top to equalize the weight distribution. Due consideration shall be paid to ensure that the tank top is not overstressed during voyage and during loading by a pile of the cargo.";

under the section for "Precautions", in the sixteenth sentence, after the words "to support life", add "*" with the following footnote:

* Refer to the *Revised recommendations for entering enclosed spaces aboard ships*, adopted by the Organization by resolution A.1050(27).";

and under the sections for "Carriage" and "Discharge", replace the words "(> 25% LEL)" with "(> 25% lower explosive limit (LEL))".

DISTILLERS DRIED GRAINS WITH SOLUBLES

72 In the individual schedule for "DISTILLERS DRIED GRAINS WITH SOLUBLES", under the section for "Loading", in the second sentence, replace the words "of the Code" with the words "of this Code".

DOLOMITE

73 In the individual schedule for "DOLOMITE", under the section for "Loading", replace the words "of the Code" with the words "of this Code".

FELSPAR LUMP

74 In the individual schedule for "FELSPAR LUMP", under the section for "Loading", replace the words "of the Code" with the words "of this Code".

FERROCHROME

75 In the individual schedule for "FERROCHROME", under the section for "Loading", in the first sentence, replace the words "of the Code" with the words "of this Code".

FERROCHROME, exothermic

76 In the individual schedule for "FERROCHROME, exothermic", under the section for "Loading", in the first sentence, replace the words "of the Code" with the words "of this Code".

FERROMANGANESE

77 In the individual schedule for "FERROMANGANESE", under the section for "Loading", in the first sentence, replace the words "of the Code" with the words "of this Code".

FERRONICKEL

78 In the individual schedule for "FERRONICKEL", under the section for "Loading", in the first sentence, replace the words "of the Code" with the words "of this Code".

FERROPHOSPHORUS (including briquettes)

79 In the individual schedule for "FERROPHOSPHORUS (including briquettes)", under the section for "Loading", in the first sentence, replace the words "of the Code" with the words "of this Code".

FERROSILICON UN 1408 with 30% or more but less than 90% silicon (including briquettes)

80 In the individual schedule for "FERROSILICON UN 1408 with 30% or more but less than 90% silicon (including briquettes)", replace the table in the section for "Characteristics" with the following:

"

Angle of repose	Bulk density (kg/m ³)		Stowage factor (m ³ /t)
Not applicable	1,389 to 2,083 (1,111 to 1,538 for briquettes)		0.48 to 0.72 (0.65 to 0.90 for briquettes)
Size	Class	Subsidiary risk	Group
Up to 300 mm briquettes	4.3	6.1	B

"

Under the section for "Loading", in the first sentence, replace the words "of the Code" with the words "of this Code"; and replace the sentences "As the density of the cargo is extremely high, the tank top may be overstressed unless the cargo is evenly spread across the tank top to equalize the weight distribution. Due consideration shall be paid to ensure that the tank top is not overstressed during voyage and during loading by a pile of the cargo." with the following:

"When the stowage factor of this cargo is equal to or less than 0.56 m³/t, the tank top may be overstressed unless the cargo is evenly spread across the tank top to equalize the weight distribution. Due consideration shall be given to ensure that the tank top is not overstressed during the voyage and during loading by a pile of the cargo.";

and under the section for "Operational requirements" in the appendix, in (vii), after the words "below 18%", add "**" with the following footnote:

** Refer to the *Revised recommendations for entering enclosed spaces aboard ships*, adopted by the Organization by resolution A.1050(27)."

FERROSILICON 25% to 30% silicon, or 90% or more silicon (including briquettes)

81 In the individual schedule for "FERROSILICON 25% to 30% silicon, or 90% or more silicon (including briquettes)", the Bulk Cargo Shipping Name is replaced with following:

"FERROSILICON with at least 25% but less than 30% silicon, or 90% or more silicon";

in the table of "Characteristics", under the section for "Size", the words "Diameter: 2.54" are replaced with "Up to 300 mm briquettes". Under the section for "Loading", in the first sentence, replace the words "of the Code" with the words "of this Code"; and replace the sentences "As the density of the cargo is extremely high, the tank top may be overstressed unless the cargo is evenly spread across the tank top to equalize the weight distribution. Due consideration shall be paid to ensure that the tank top is not overstressed during voyage and during loading by a pile of the cargo." with the following:

"When the stowage factor of this cargo is equal to or less than 0.56 m³/t, the tank top may be overstressed unless the cargo is evenly spread across the tank top to equalize the weight distribution. Due consideration shall be given to ensure that the tank top is not overstressed during the voyage and during loading by a pile of the cargo.";

and under the section for "Operational requirements" in the appendix, in (vii), after the words "below 18%", add "**" with the following footnote:

** Refer to the *Revised recommendations for entering enclosed spaces aboard ships*, adopted by the Organization by resolution A.1050(27)."

FERROUS METAL BORINGS, SHAVINGS, TURNINGS or CUTTINGS UN 2793 in a form liable to self-heating

82 In the individual schedule for "FERROUS METAL BORINGS, SHAVINGS, TURNINGS or CUTTINGS UN 2793 in a form liable to self-heating", under the section for "Discharge", after the words "appropriate breathing apparatus", add "**" with the following footnote:

** Refer to the *Revised recommendations for entering enclosed spaces aboard ships*, adopted by the Organization by resolution A.1050(27)."

FERROUS SULPHATE HEPTAHYDRATE

83 In the individual schedule for "FERROUS SULPHATE HEPTAHYDRATE", under the section for "Loading", replace the words "of the Code" with the words "of this Code".

FERTILIZERS WITHOUT NITRATES (non-hazardous)

84 In the individual schedule for "FERTILIZERS WITHOUT NITRATES (non-hazardous)", under the section for "Loading", replace the words "of the Code" with the words "of this Code".

FISH (IN BULK)

85 In the individual schedule for "FISH (IN BULK)", under the section for "Loading", replace the words "of the Code" with the words "of this Code". Under the section for "Carriage", replace the words "No special requirements" with the following:

"The appearance of the surface of this cargo shall be checked regularly during voyage. If free water above the cargo or fluid state of the cargo is observed during voyage, the master shall take appropriate actions to prevent cargo shifting and potential capsizing of the ship, and give consideration to seeking emergency entry into a place of refuge."

FISHMEAL (FISHSCRAP), STABILIZED UN 2216 Anti-oxidant treated

86 In the individual schedule for "FISHMEAL (FISHSCRAP), STABILIZED UN 2216 Anti-oxidant treated", in the provision under the Bulk Cargo Shipping Name, delete the term "Group C,"; and under the section for "Loading", in the first sentence, replace the words "of the Code" with the words "of this Code".

FLUORSPAR

87 In the individual schedule for "FLUORSPAR", under the section for "Hazard", replace the first and second sentence with:

"This cargo may liquefy if shipped at a moisture content in excess of its transportable moisture limit (TML). See sections 7 and 8 of this Code.";

under the section for "Loading", replace the words "of the Code" with the words "of this Code"; add the following text:

"When the stowage factor of this cargo is equal to or less than 0.56 m³/t, the tank top may be overstressed unless the cargo is evenly spread across the tank top to equalize the weight distribution. Due consideration shall be given to ensure that the tank top is not overstressed during the voyage and during loading by a pile of the cargo.";

under the section for "Weather precautions", replace paragraphs .1 and .4 with the following sentences, respectively:

".1 the moisture content of the cargo shall be kept less than its TML during loading operations and the voyage;"

and

".4 the cargo may be handled during precipitation under the conditions stated in the procedures required in paragraph 4.3.3 of this Code; and";

and under the section for "Carriage", replace the sentence "No special requirements." with the following:

"The appearance of the surface of this cargo shall be checked regularly during voyage. If free water above the cargo or fluid state of the cargo is observed during voyage, the master shall take appropriate actions to prevent cargo shifting and potential capsizing of the ship, and give consideration to seeking emergency entry into a place of refuge."

FLY ASH, DRY

88 In the individual schedule for "FLY ASH, DRY", under the section for "Loading", in the first sentence, replace the words "of the Code" with the words "of this Code". Under the section for "Clean-up", replace the words "FLY ASH" with "fly ash".

FLY ASH, WET

89 In the individual schedule for "FLY ASH, WET", under the section for "Hazard", replace the first sentence with:

"This cargo may liquefy if shipped at a moisture content in excess of its transportable moisture limit (TML). See sections 7 and 8 of this Code.";

under the section for "Weather precautions", replace paragraphs .1 and .4 with the following sentences, respectively:

".1 the moisture content of the cargo shall be kept less than its TML during loading operations and the voyage;"

and

".4 the cargo may be handled during precipitation under the conditions stated in the procedures required in paragraph 4.3.3 of this Code; and";

and under the section for "Loading", replace the words "of the Code" with the words "of this Code".

GLASS CULLET

90 In the existing individual schedule for "GLASS CULLET", at the end of the section for "Description", add the following text:

"It may also be flint flat glass cullet which may have a grey or ochre appearance caused by adherent glass dust. May have a slight odour caused by organic impurities (plastics, foil). Used for glass production (bottle industry).";

and replace the existing table of "Characteristics", with the following:

"

Angle of repose	Bulk density (kg/m3)	Stowage factor (m3/t)
Not applicable	600 to 1,330	0.75 to 1.67
Size	Class	Group
Up to 2,000 mm	Not applicable	C

"

GRAIN SCREENING PELLETS

91 In the individual schedule for "GRAIN SCREENING PELLETS", under the section for "Loading", in the first sentence, replace the words "under sections 4, 5 and 6 of the Code" with the words "under sections 4 and 5 of this Code", and delete the words "in accordance with the shipper's declaration of the angle of repose".

GRANULAR FERROUS SULPHATE

92 In the individual schedule for "GRANULAR FERROUS SULPHATE", under the section for "Loading", replace the words "under sections 4, 5 and 6 of the Code" with the words "under sections 4 and 5 of this Code".

GRANULATED NICKEL MATTE (LESS THAN 2% MOISTURE CONTENT)

93 In the individual schedule for "GRANULATED NICKEL MATTE (LESS THAN 2% MOISTURE CONTENT)", under the section for "Loading", in the first sentence, replace the words "of the Code" with the words "of this Code".

GRANULATED SLAG

94 In the individual schedule for "GRANULATED SLAG", under the section for "Loading", in the first sentence, replace the words "of the Code" with the words "of this Code".

GRANULATED TYRE RUBBER

95 In the individual schedule for "GRANULATED TYRE RUBBER", under the section for "Loading", replace the words "of the Code" with the words "of this Code".

GYPSUM

96 In the individual schedule for "GYPSUM", under the section for "Loading", replace the words "of the Code" with the words "of this Code".

GYPHUM GRANULATED

97 In the individual schedule for "GYPHUM GRANULATED", under the section for "Loading", replace the words "of the Code" with the words "of this Code".

ILMENITE CLAY

98 In the individual schedule for "ILMENITE CLAY", under the section for "Hazard", replace the first sentence with:

"This cargo may liquefy if shipped at a moisture content in excess of its transportable moisture limit (TML). See sections 7 and 8 of this Code.";

under the section for "Weather precautions", replace paragraphs .1 and .4 with the following sentences, respectively:

".1 the moisture content of the cargo shall be kept less than its TML during loading operations and the voyage;"

and

".4 the cargo may be handled during precipitation under the conditions stated in the procedures required in paragraph 4.3.3 of this Code; and";

and under the section for "Loading", in the first sentence, replace the words "of the Code" with the words "of this Code".

ILMENITE (ROCK)

99 In the individual schedule for "ILMENITE (ROCK)", under the section for "Loading", in the first sentence, replace the words "of the Code" with the words "of this Code".

ILMENITE SAND

100 In the existing individual schedule for "ILMENITE SAND", under the Bulk Cargo Shipping Name, delete the sentence "This cargo can be categorized as Group A or C.". Under the section for "Description", delete the sentences "The moisture content of this cargo in Group C is 1% to 2%. When moisture content is above 2%, this cargo is to be categorized in Group A." In the table of "Characteristics", in the column for "Group", delete the words "or C". Replace the text under the section for "Hazard" with following:

"This cargo may liquefy if shipped at a moisture content in excess of its transportable moisture limit (TML). See sections 7 and 8 of this Code. This cargo is non-combustible or has a low fire-risk.";

and under the section for "Loading", in the first sentence, replace the words "of the Code" with the words "of this Code". Replace the text under the section for "Weather precautions" with the following:

"When a cargo is carried in a ship other than a ship complying with the requirements in subsection 7.3.2 of this Code, the following provisions shall be complied with:

.1 the moisture content of the cargo shall be kept less than its TML during loading operations and the voyage;

- .2 unless expressly provided otherwise in this individual schedule, the cargo shall not be handled during precipitation;
- .3 unless expressly provided otherwise in this individual schedule, during handling of the cargo, all non-working hatches of the cargo spaces into which the cargo is loaded or to be loaded shall be closed;
- .4 the cargo may be handled during precipitation under the conditions stated in the procedures required in paragraph 4.3.3 of this Code; and
- .5 the cargo in a cargo space may be discharged during precipitation provided that the total amount of the cargo in the cargo space is to be discharged in the port."

ILMENITE (UPGRADED)

101 In the individual schedule for "ILMENITE (UPGRADED)", under the section for "Hazard", in the first sentence, add the word "a" before the words "moisture content". Under the section for "Loading", in the first sentence, replace the words "of the Code" with the words "of this Code".

IRON ORE FINES

102 In the individual schedule for "IRON ORE FINES", under the section for "Hazard", add the word "a" before the words "moisture content". Under the section for "Carriage", in the second sentence, delete the words "as far as practicable".

IRON ORE PELLETS

103 In the individual schedule for "IRON ORE PELLETS", under the section for "Loading", in the first sentence, replace the words "of the Code" with the words "of this Code".

IRON OXIDE, SPENT or IRON SPONGE, SPENT UN 1376 obtained from coal gas purification

104 In the individual schedule for "IRON OXIDE, SPENT or IRON SPONGE, SPENT UN 1376 obtained from coal gas purification", under the section for "Loading", in the first sentence, replace the words "of the Code" with the words "of this Code".

IRON OXIDE TECHNICAL

105 In the individual schedule for "IRON OXIDE TECHNICAL", under the section for "Hazard", add the word "a" before the words "moisture content".

IRONSTONE

106 In the individual schedule for "IRONSTONE", under the section for "Loading", in the first sentence, replace the words "of the Code" with the words "of this Code".

LABRADORITE

107 In the individual schedule for "LABRADORITE", under the section for "Loading", replace the words "of the Code" with the words "of this Code".

LEAD NITRATE UN 1469

108 In the individual schedule for "LEAD NITRATE UN 1469", under the section for "Loading", replace the words "of the Code" with the words "of this Code".

LEAD ORE

109 In the individual schedule for "LEAD ORE", under the section for "Loading", in the first sentence, replace the words "of the Code" with the words "of this Code" and replace the text "As the density of the cargo is extremely high, the tank top may be overstressed unless the cargo is evenly spread across the tank top to equalize the weight distribution. Due consideration shall be paid to ensure that the tank top is not overstressed during voyage and during loading by a pile of the cargo." with the following:

"When the stowage factor of this cargo is equal to or less than 0.56 m³/t, the tank top may be overstressed unless the cargo is evenly spread across the tank top to equalize the weight distribution. Due consideration shall be given to ensure that the tank top is not overstressed during the voyage and during loading by a pile of the cargo."

LIME (UNSLAKED)

110 In the individual schedule for "LIME (UNSLAKED)", under the section for "Loading", replace the words "of the Code" with the words "of this Code".

LIMESTONE

111 In the individual schedule for "LIMESTONE", under the section for "Loading", replace the words "of the Code" with the words "of this Code".

LINTED COTTON SEED with not more than 9% moisture and not more than 20.5% oil

112 In the individual schedule for "LINTED COTTON SEED with not more than 9% moisture and not more than 20.5% oil", under the section for "Loading", replace the words "of the Code" with the words "of this Code";

under the section for "Precautions", after the words "concentration of oxygen", add "*" with the following footnote:

* Refer to the *Revised recommendations for entering enclosed spaces aboard ships*, adopted by the Organization by resolution A.1050(27).";

and under the section for "Carriage", replace the word "should" with the word "shall".

MAGNESIA (DEADBURNED)

113 In the individual schedule for "MAGNESIA (DEADBURNED)", under the section for "Loading", replace the words "of the Code" with the words "of this Code"; and add the following text:

"As the density of the cargo is extremely high, the tank top may be overstressed unless the cargo is evenly spread across the tank top to equalize the weight distribution. Due consideration shall be paid to ensure that the tank top is not overstressed during the voyage and during loading by a pile of the cargo."

MAGNESIA (UNSLAKED)

114 In the individual schedule for "MAGNESIA (UNSLAKED)", under the section for "Loading", replace the words "of the Code" with the words "of this Code".

MAGNESITE, natural

115 In the individual schedule for "MAGNESITE, natural", under the section for "Loading", replace the words "of the Code" with the words "of this Code".

MAGNESIUM NITRATE UN 1474

116 In the individual schedule for "MAGNESIUM NITRATE UN 1474", under the section for "Loading", replace the words "of the Code" with the words "of this Code".

MAGNESIUM SULPHATE FERTILIZERS

117 In the individual schedule for "MAGNESIUM SULPHATE FERTILIZERS", under the section for "Loading", replace the words "under sections 4, 5 and 6 of the Code" with the words "under sections 4 and 5 of this Code".

MANGANESE ORE

118 In the individual schedule for "MANGANESE ORE", under the section for "Loading", in the first sentence, replace the words "of the Code" with the words "of this Code". Replace the text "As the density of the cargo is extremely high, the tank top may be overstressed unless the cargo is evenly spread across the tank top to equalize the weight distribution. Due consideration shall be paid to ensure that the tank top is not overstressed during voyage and during loading by a pile of the cargo." with the following:

"When the stowage factor of this cargo is equal to or less than 0.56 m³/t, the tank top may be overstressed unless the cargo is evenly spread across the tank top to equalize the weight distribution. Due consideration shall be given to ensure that the tank top is not overstressed during the voyage and during loading by a pile of the cargo."

MANGANESE ORE FINES

119 In the individual schedule for "MANGANESE ORE FINES", under the section for "Hazard", in the first sentence, add the word "a" before the words "moisture content".

MARBLE CHIPS

120 In the individual schedule for "MARBLE CHIPS", under the section for "Loading", replace the words "of the Code" with the words "of this Code".

METAL SULPHIDE CONCENTRATES

121 In the individual schedule for "METAL SULPHIDE CONCENTRATES", in the table of "Characteristics", under "Class", after the word "MHB", add "(SH) and/or (CR) and/or (TX)". Under the section for "Hazard", add a first sentence as follows:

"Some metal sulphide concentrates may have acute and long term health effects.";

add the following text at the beginning of the section:

"This cargo may liquefy if shipped at a moisture content in excess of its transportable moisture limit (TML). See sections 7 and 8 of this Code.";

under the section for "Weather precautions", replace paragraphs .1 and .4 with the following sentences, respectively:

".1 the moisture content of the cargo shall be kept less than its TML during loading operations and the voyage;"

and

".4 the cargo may be handled during precipitation under the conditions stated in the procedures required in paragraph 4.3.3 of this Code; and";

under the section for "Loading", replace the first sentence with the following:

"This cargo shall be trimmed to ensure that the height difference between peaks and troughs does not exceed 5% of the ship's breadth and that the cargo slopes uniformly from the hatch boundaries to the bulkheads to avoid steep surfaces of cargo that could collapse during voyage.";

and under the section for "Precautions", after the words "concentration of oxygen", add "*" with the following footnote:

* Refer to the *Revised recommendations for entering enclosed spaces aboard ships*, adopted by the Organization by resolution A.1050(27)."

Mineral Concentrates

122 In the individual schedule for "Mineral Concentrates", under the section for "Hazard", replace the first and second sentence with:

"The above materials may liquefy if shipped at a moisture content in excess of their transportable moisture limit (TML). See sections 7 and 8 of this Code.";

under the section for "Weather precautions", replace paragraphs .1 and .4 with the following sentences, respectively:

".1 the moisture content of the cargo shall be kept less than its TML during loading operations and the voyage;"

and

".4 the cargo may be handled during precipitation under the conditions stated in the procedures required in paragraph 4.3.3 of this Code; and";

and replace the text under the section for "Loading" with the following:

"This cargo shall be trimmed to ensure that the height difference between peaks and troughs does not exceed 5% of the ship's breadth and that the cargo slopes uniformly from the hatch boundaries to the bulkheads to avoid steep surfaces of cargo that could collapse during voyage.

When the stowage factor of this cargo is equal to or less than 0.56 m³/t, the tank top may be overstressed unless the cargo is evenly spread across the tank top to equalize the weight distribution. Due consideration shall be given to ensure that the tank top is not overstressed during the voyage and during loading by a pile of the cargo."

MONOAMMONIUM PHOSPHATE (M.A.P.)

123 In the individual schedule for "MONOAMMONIUM PHOSPHATE (M.A.P.)", under the section for "Loading", replace the words "under sections 4, 5 and 6 of the Code" with the words "under sections 4 and 5 of this Code".

NICKEL ORE

124 In the individual schedule for "NICKEL ORE", under the section for "Weather precautions", replace paragraph .1 with following:

.1 the moisture content of the cargo shall be kept less than its TML during loading operations and the voyage;"

and under the section for "Loading", in the first sentence, replace the words "of the Code" with the words "of this Code".

PEANUTS (in shell)

125 In the individual schedule for "PEANUTS (in shell)", under the section for "Loading", replace the words "of the Code" with the words "of this Code".

PEAT MOSS

126 In the individual schedule for "PEAT MOSS", under the section for "Hazard", add the following text at the beginning:

"This cargo may liquefy if shipped at a moisture content in excess of its transportable moisture limit (TML). See sections 7 and 8 of this Code.";

and under the section for "Loading", replace the words "of the Code" with the words "of this Code". Under the section for "Precautions", after the words "a normal level", add "*" with the following footnote:

* Refer to the *Revised recommendations for entering enclosed spaces aboard ships*, adopted by the Organization by resolution A.1050(27)."

PEBBLES (sea)

127 In the individual schedule for "PEBBLES (sea)", under the section for "Loading", replace the words "of the Code" with the words "of this Code".

PELLETS (concentrates)

128 In the individual schedule for "PELLETS (concentrates)", under the section for "Loading", replace the words "of the Code" with the words "of this Code"; and add the following text at the end of the section:

"As the density of the cargo is extremely high, the tank top may be overstressed unless the cargo is evenly spread across the tank top to equalize the weight distribution. Due consideration shall be paid to ensure that the tank top is not overstressed during the voyage and during loading by a pile of the cargo."

PERLITE ROCK

129 In the individual schedule for "PERLITE ROCK", under the section for "Loading", replace the words "of the Code" with the words "of this Code".

PHOSPHATE (defluorinated)

130 In the individual schedule for "PHOSPHATE (defluorinated)", under the section for "Loading", replace the words "of the Code" with the words "of this Code".

PHOSPHATE ROCK (calcined)

131 In the individual schedule for "PHOSPHATE ROCK (calcined)", under the section for "Loading", replace the words "of the Code" with the words "of this Code".

PHOSPHATE ROCK (uncalcined)

132 In the individual schedule for "PHOSPHATE ROCK (uncalcined)", under the section for "Loading", replace the words "of the Code" with the words "of this Code".

PIG IRON

133 In the individual schedule for "PIG IRON", under the section for "Loading", in the third sentence, replace the words "of the Code" with the words "of this Code".

PITCH PRILL

134 In the individual schedule for "PITCH PRILL", under the section for "Loading", in the first sentence, replace the words "of the Code" with the words "of this Code".

POTASH

135 In the individual schedule for "POTASH", under the section for "Loading", replace the words "under sections 4, 5 and 6 of the Code" with the words "under sections 4 and 5 of this Code".

POTASSIUM CHLORIDE

136 In the individual schedule for "POTASSIUM CHLORIDE", under the section for "Loading", replace the words "under sections 4, 5 and 6 of the Code" with the words "under sections 4 and 5 of this Code".

POTASSIUM NITRATE UN 1486

137 In the individual schedule for "POTASSIUM NITRATE UN 1486", under the section for "Loading", replace the words "under sections 4, 5 and 6 of the Code" with the words "under sections 4 and 5 of this Code".

POTASSIUM SULPHATE

138 In the individual schedule for "POTASSIUM SULPHATE", under the section for "Loading", replace the words "under sections 4, 5 and 6 of the Code" with the words "under sections 4 and 5 of this Code".

PUMICE

139 In the individual schedule for "PUMICE", under the section for "Loading", replace the words "of the Code" with the words "of this Code".

PYRITE (containing copper and iron)

140 In the individual schedule for "PYRITE (containing copper and iron)", under the section for "Loading", in the first sentence, replace the words "of the Code" with the words "of this Code".

PYRITES, CALCINED (Calcined Pyrites)

141 In the individual schedule for "PYRITES, CALCINED (Calcined Pyrites)", under the section for "Hazard", replace the third sentence with the following:

"This cargo may liquefy if shipped at a moisture content in excess of its transportable moisture limit (TML). See sections 7 and 8 of this Code.";

under the section for "Loading", in the first sentence, replace the words "of the Code" with the words "of this Code".

PYROPHYLLITE

142 In the individual schedule for "PYROPHYLLITE", under the section for "Loading", replace the words "of the Code" with the words "of this Code"; add the following text at the end of the section:

"As the density of the cargo is extremely high, the tank top may be overstressed unless the cargo is evenly spread across the tank top to equalize the weight distribution. Due consideration shall be paid to ensure that the tank top is not overstressed during the voyage and during loading by a pile of the cargo."

QUARTZ

143 In the individual schedule for "QUARTZ", under the section for "Loading", replace the words "of the Code" with the words "of this Code".

QUARTZITE

144 In the individual schedule for "QUARTZITE", under the section for "Loading", replace the words "of the Code" with the words "of this Code".

RADIOACTIVE MATERIAL, LOW SPECIFIC ACTIVITY (LSA-I), non-fissile or fissile – excepted UN 2912

145 In the individual schedule for "RADIOACTIVE MATERIAL, LOW SPECIFIC ACTIVITY (LSA-I), non-fissile or fissile – excepted UN 2912", under the section for "Loading", replace the words "of the Code" with the words "of this Code".

RADIOACTIVE MATERIAL, SURFACE CONTAMINATED OBJECTS (SCO-I), non-fissile or fissile – excepted UN 2913

146 In the individual schedule for "RADIOACTIVE MATERIAL, SURFACE CONTAMINATED OBJECTS (SCO-I), non-fissile or fissile – excepted UN 2913", under the section for "Loading", replace the words "of the Code" with the words "of this Code".

RASORITE (ANHYDROUS)

147 In the individual schedule for "RASORITE (ANHYDROUS)", under the section for "Loading", replace the words "of the Code" with the words "of this Code".

RUTILE SAND

148 In the individual schedule for "RUTILE SAND", under the section for "Loading", in the first sentence, replace the words "of the Code" with the words "of this Code".

SALT

149 In the individual schedule for "SALT", under the section for "Loading", replace the words "of the Code" with the words "of this Code".

SALT CAKE

150 In the individual schedule for "SALT CAKE", under the section for "Loading", replace the words "of the Code" with the words "of this Code".

SALT ROCK

151 In the individual schedule for "SALT ROCK", under the section for "Loading", replace the words "of the Code" with the words "of this Code".

SAND

152 In the individual schedule for "SAND", under the section for "Loading", replace the words "of the Code" with the words "of this Code". Add the following text at the end of the section:

"When the stowage factor of this cargo is equal to or less than 0.56 m³/t, the tank top may be overstressed unless the cargo is evenly spread across the tank top to equalize the weight distribution. Due consideration shall be given to ensure that the tank top is not overstressed during the voyage and during loading by a pile of the cargo."

SAND, HEAVY MINERAL

153 In the individual schedule for "SAND, HEAVY MINERAL", under the section for "Loading", replace the words "of the Code" with the words "of this Code".

SAWDUST

154 In the individual schedule for "SAWDUST", under the section for "Loading", replace the words "of the Code" with the words "of this Code".

SCALE GENERATED FROM THE IRON AND STEEL MAKING PROCESS

155 In the individual schedule for "SCALE GENERATED FROM THE IRON AND STEEL MAKING PROCESS", under the section for "Hazard", add the word "a" before the words "moisture content".

SEED CAKE, containing vegetable oil UN 1386 (a) mechanically expelled seeds, containing more than 10% of oil or more than 20% of oil and moisture combined

156 In the individual schedule for "SEED CAKE, containing vegetable oil UN 1386 (a) mechanically expelled seeds, containing more than 10% of oil or more than 20% of oil and moisture combined", under the section for "Loading", replace the words "of the Code" with the words "of this Code". Under the section for "Precautions", after the words "a normal level", add "*" with the following footnote:

"* Refer to the *Revised recommendations for entering enclosed spaces aboard ships*, adopted by the Organization by resolution A.1050(27)."

SEED CAKE, containing vegetable oil UN 1386 (b) solvent extractions and expelled seeds, containing not more than 10% of oil and when the amount of moisture is higher than 10%, not more than 20% of oil and moisture combined

157 In the individual schedule for "SEED CAKE, containing vegetable oil UN 1386 (b) solvent extractions and expelled seeds, containing not more than 10% of oil and when the amount of moisture is higher than 10%, not more than 20% of oil and moisture combined", in the sentence "When, in solvent extracted seed cake, the oil or oil and moisture content exceeds the percentages stated above, guidance should be sought from the competent authorities." after BCSN, replace the word "should" with the word "shall". Under the section for "Loading", in the last sentence, replace the words "of the Code" with the words "of this Code". Under the section for "Ventilation", replace the word "should" with the word "shall". Under the section for "Precautions", after the words "a normal level", add "*" with the following footnote:

"* Refer to the *Revised recommendations for entering enclosed spaces aboard ships*, adopted by the Organization by resolution A.1050(27)."

SEED CAKE UN 2217 with not more than 1.5% oil and not more than 11% moisture

158 In the individual schedule for "SEED CAKE UN 2217 with not more than 1.5% oil and not more than 11% moisture", under the section for "Loading", in the second sentence, replace the words "of the Code" with the words "of this Code". Under the section for "Ventilation", replace the word "should" with the word "shall". Under the section for "Precautions", after the words "a normal level", add "*" with the following footnote:

"* Refer to the *Revised recommendations for entering enclosed spaces aboard ships*, adopted by the Organization by resolution A.1050(27)."

SEED CAKE (non-hazardous)

159 In the individual schedule for "SEED CAKE (non-hazardous)", under the section for "Loading", in the first sentence, replace the words "of the Code" with the words "of this Code".

SILICOMANGANESE (low carbon)

160 In the individual schedule for "SILICOMANGANESE (low carbon)", under the section for "Loading", in the first sentence, replace the words "of the Code" with the words "of this Code". Under the section for "Precautions", replace the word "should" with the word "shall"; after the words "has been effected", add "*" with the following footnote:

"* Refer to the *Revised recommendations for entering enclosed spaces aboard ships*, adopted by the Organization by resolution A.1050(27)."

SILICON SLAG

161 In the individual schedule for "SILICON SLAG", in the table of "Characteristics", under the column "Bulk density (kg/m³)", the numerical value "2,300" is replaced with "1,500"; under the column for "Stowage factor (m³/t)", the numerical value "0.43" is replaced with "0.67". Under the section for "Loading", in the first sentence, replace the words "of the Code" with the words "of this Code"; and the second and third sentences are replaced with following:

"When the stowage factor of this cargo is equal or less than 0.56 m³/t, the tank top may be overstressed unless the cargo is evenly spread across the tank top to equalize the weight distribution. Due consideration shall be given to ensure that the tank top is not overstressed during the voyage and during loading by a pile of the cargo."

SODA ASH (Dense and light)

162 In the individual schedule for "SODA ASH (Dense and light)", under the section for "Loading", replace the words "of the Code" with the words "of this Code".

SODIUM NITRATE UN 1498

163 In the individual schedule for "SODIUM NITRATE UN 1498", under the section for "Loading", replace the words "of the Code" with the words "of this Code".

SODIUM NITRATE AND POTASSIUM NITRATE MIXTURE UN 1499

164 In the individual schedule for "SODIUM NITRATE AND POTASSIUM NITRATE MIXTURE UN 1499", under the section for "Loading", replace the words "under sections 4, 5 and 6 of the Code" with the words "under sections 4 and 5 of this Code".

SOLIDIFIED FUELS RECYCLED FROM PAPER AND PLASTICS

165 In the individual schedule for "SOLIDIFIED FUELS RECYCLED FROM PAPER AND PLASTICS", under the section for "Loading", in the second sentence, replace the words "of the Code" with the words "of this Code". Under the section for "Precautions", after the words "sufficiently ventilated", add "*" with the following footnote:

* Refer to the *Revised recommendations for entering enclosed spaces aboard ships*, adopted by the Organization by resolution A.1050(27)."

SPODUMENE (UPGRADED)

166 In the individual schedule for "SPODUMENE (UPGRADED)", under the section for "Hazard", add the word "a" before the words "moisture content".

STAINLESS STEEL GRINDING DUST

167 In the individual schedule for "STAINLESS STEEL GRINDING DUST", under the section for "Loading", in the first sentence, replace the words "of the Code" with the words "of this Code".

STONE CHIPPINGS

168 In the individual schedule for "STONE CHIPPINGS", under the section for "Loading", replace the words "of the Code" with the words "of this Code".

SUGAR

169 In the individual schedule for "SUGAR", under the section for "Loading", replace the words "of the Code" with the words "of this Code".

SULPHUR (formed, solid)

170 In the individual schedule for "SULPHUR (formed, solid)", under the section for "Loading", in the first sentence, replace the words "of the Code" with the words "of this Code".

SULPHUR UN 1350 (crushed lump and coarse grained)

171 In the individual schedule for "SULPHUR UN 1350 (crushed lump and coarse grained)", under the section for "Loading", replace the words "of the Code" with the words "of this Code".

SUPERPHOSPHATE

172 In the individual schedule for "SUPERPHOSPHATE", under the section for "Loading", replace the words "under sections 4, 5 and 6 of the Code" with the words "under sections 4 and 5 of this Code".

SUPERPHOSPHATE (triple, granular)

173 In the individual schedule for "SUPERPHOSPHATE (triple, granular)", under the section for "Loading", replace the words "of the Code" with the words "of this Code". Under the sections for "Precautions" and "Clean-up", respectively, replace the word "should" with the word "shall".

TACONITE PELLETS

174 In the individual schedule for "TACONITE PELLETS", under the section for "Loading", replace the words "of the Code" with the words "of this Code".

TALC

175 In the individual schedule for "TALC", under the section for "Loading", replace the words "of the Code" with the words "of this Code".

TANKAGE

176 In the individual schedule for "TANKAGE", under the section for "Loading", replace the words "of the Code" with the words "of this Code".

TAPIOCA

177 In the individual schedule for "TAPIOCA", under the section for "Loading", replace the words "under sections 4, 5 and 6 of the Code" with the words "under sections 4 and 5 of this Code".

UREA

178 In the individual schedule for "UREA", under the section for "Loading", replace the words "under sections 4, 5 and 6 of the Code" with the words "under sections 4 and 5 of this Code".

VANADIUM ORE

179 In the individual schedule for "VANADIUM ORE", under the section for "Loading", replace the words "of the Code" with the words "of this Code"; add the following text at the end of the section:

"As the density of the cargo is extremely high, the tank top may be overstressed unless the cargo is evenly spread across the tank top to equalize the weight distribution. Due consideration shall be paid to ensure that the tank top is not overstressed during the voyage and during loading by a pile of the cargo.";

and under the section for "Precautions", replace the word "should" with the word "shall".

VERMICULITE

180 In the individual schedule for "VERMICULITE", under the section for "Loading", replace the words "of the Code" with the words "of this Code".

WHITE QUARTZ

181 In the individual schedule for "WHITE QUARTZ", under the section for "Loading", replace the words "of the Code" with the words "of this Code".

WOODCHIPS

182 In the individual schedule for "WOODCHIPS", under the section for "Loading", replace the words "of the Code" with the words "of this Code". Under the section for "Precautions", in the first and second sentences, respectively, replace the word "should" with the word "shall"; after the words "oxygen level is 20.7%", add "*" with the following footnote:

* Refer to the *Revised recommendations for entering enclosed spaces aboard ships*, adopted by the Organization by resolution A.1050(27)."

WOOD PELLETS CONTAINING ADDITIVES AND/OR BINDERS

183 In the individual schedule for "WOOD PELLETS CONTAINING ADDITIVES AND/OR BINDERS", under the section for "Description", the fifth sentence is replaced with the following:

"The raw material is compressed to approximately one-third of its original volume. The finished wood pellets typically have a moisture content of 4% to 8%.;"

under the section for "Loading", replace the words "under sections 4, 5 and 6 of this Code" with the words "under sections 4 and 5 of this Code"; and under the section for "Precautions", after the words "carbon monoxide <100 ppm", add "*" with the following footnote:

* Refer to the *Revised recommendations for entering enclosed spaces aboard ships*, adopted by the Organization by resolution A.1050(27)."

WOOD PELLETS NOT CONTAINING ANY ADDITIVES AND/OR BINDERS

184 In the individual schedule for "WOOD PELLETS NOT CONTAINING ANY ADDITIVES AND/OR BINDERS", under the section for "Description", the fifth sentence is replaced with the following:

"The raw material is compressed to approximately one-third of its original volume. The finished wood pellets typically have a moisture content of 4% to 8%.";

under the section for "Loading", replace the words "under sections 4, 5 and 6 of this Code" with the words "under sections 4 and 5 of this Code". Under the section for "Precautions", after the words "carbon monoxide <100 ppm", add "*" with the following footnote:

* Refer to the *Revised recommendations for entering enclosed spaces aboard ships*, adopted by the Organization by resolution A.1050(27)."

Wood Products – General

185 In the individual schedule for "Wood Products – General", under the section for "Precautions", after the words "oxygen level is 21%", add "*" with the following footnote:

* Refer to the *Revised recommendations for entering enclosed spaces aboard ships*, adopted by the Organization by resolution A.1050(27).";

and under the section for "Loading", in the first sentence, replace the words "of the Code" with the words "of this Code".

WOOD TORREFIED

186 In the individual schedule for "WOOD TORREFIED", under the section for "Loading", replace the words "section 4, 5 and 6 of the Code" with the words "section 4 and 5 of this Code". Under the section for "Precautions", after the words "carbon monoxide < 100 ppm", add "*" with the following footnote:

* Refer to the *Revised recommendations for entering enclosed spaces aboard ships*, adopted by the Organization by resolution A.1050(27)."

ZINC ASHES UN 1435

187 In the individual schedule for "ZINC ASHES UN 1435", under the section for "Loading", in the first sentence, replace the words "of the Code" with the words "of this Code".

ZINC SLAG

188 In the individual schedule for "ZINC SLAG", under the section for "Hazard", add the word "a" before the words "moisture content". Under the section for "Loading", replace the first sentence with the following:

"This cargo shall be trimmed to ensure that the height difference between peaks and troughs does not exceed 5% of the ship's breadth and that the cargo slopes uniformly from the hatch boundaries to the bulkheads to avoid steep surfaces of cargo that could collapse during the voyage."

and under the section for "Carriage", add the following text at the end of the section:

"The appearance of the surface of this cargo shall be checked regularly during voyage. If free water above the cargo or fluid state of the cargo is observed during the voyage, the master shall take appropriate actions to prevent cargo shifting and potential capsize of the ship, and give consideration to seeking emergency entry into a place of refuge."

ZIRCON KYANITE CONCENTRATE

189 In the individual schedule for "ZIRCON KYANITE CONCENTRATE", under the section for "Hazard", add the word "a" before the words "moisture content". Under the section for "Loading", replace the second and the third sentences with the following text:

"As the density of the cargo is extremely high, the tank top may be overstressed unless the cargo is evenly spread across the tank top to equalize the weight distribution. Due consideration shall be paid to ensure that the tank top is not overstressed during voyage and during loading by a pile of the cargo."

ZIRCONSAND

190 In the individual schedule for "ZIRCONSAND", under the section for "Loading", in the first sentence, replace the words "of the Code" with the words "of this Code".

New individual schedules

191 Insert the following new individual schedules accordingly in alphabetical order:

"FOAM GLASS GRAVEL

Description

Foam glass gravel is a lightweight insulation product used in the construction/building industry. This cargo is odourless and of grey anthracite colour.

Characteristics

Angle of repose	Bulk density (kg/m³)	Stowage factor (m³/t)
Not applicable	130 to 250	4.0 to 7.6
Size	Class	Group
Varies	Not applicable	C

Hazard

Dust may cause skin and eye irritation.
This cargo is non-combustible or has a low fire-risk.

Stowage & segregation

No special requirements.

Hold cleanliness

No special requirements.

Weather Precautions

No special requirements.

Loading

Trim in accordance with the relevant provisions required under sections 4 and 5 of this Code.

Precautions

Persons who may be exposed to the dust of the cargo shall wear goggles or other equivalent dust eye-protection and dust filter masks as well as protective clothing, as necessary. Bilge wells shall be clean, dry and covered as appropriate, to prevent ingress of the cargo.

Ventilation

No special requirements.

Carriage

No special requirements.

Discharge

Entry into the cargo spaces containing this cargo shall only be permitted for trained personnel wearing protective clothing and goggles or other equivalent dust eye-protection as well as dust filter masks.

Clean-up

No special requirements."

"IRON SMELTING BY-PRODUCTS

Description

This cargo is a by-product from the smelting of iron ore, ilmenite and titanomagnetite. Grey or black, small to large size lumps (up to 45 tonnes), granulated iron included. Depending on the dominant size, Iron by-products from smelting of iron ore, ilmenite and titanomagnetite is called variously:

Iron pan edges	K1-K3 bears
Separation of iron	Steel bears
Granulated iron	Pig iron by-product
Plate iron	Beach iron
Pool iron	Iron skulls
Flat iron	

Characteristics

Angle of repose	Bulk density (kg/m ³)	Stowage factor (m ³ /t)
Not applicable	Varies	Varies
Size	Class	Group
Varies	Not applicable	C

Hazard

No special hazards.

This cargo is non-combustible or has a low fire-risk.

Stowage & segregation

No special requirements.

Hold cleanliness

No special requirements.

Weather precautions

No special requirements.

Loading

Trim in accordance with the relevant provisions required under sections 4 and 5 of this Code.

The tank top may be overstressed unless the cargo is evenly spread across the tank top to equalize the weight distribution. Due consideration shall be paid to ensure that the tank top is not overstressed during voyage and during loading by a pile of the cargo. Large pieces shall not be dropped in the cargo hold and placement of very large lumps shall be such that the tank top is not overstressed by point loads. The weight distribution in the hold shall be considered during loading.

Precautions

Bilge wells of the cargo spaces shall be protected from ingress of the cargo.

Ventilation

No special requirements.

Carriage

No special requirements.

Discharge

When this cargo is discharged by magnet or spider grab:

- .1 the deck and deck machineries shall be protected from falling cargo; and
- .2 damages to the ship shall be checked, after the completion of discharge.

Clean-up

No special requirements."

"METAL SULPHIDE CONCENTRATES, CORROSIVE UN 1759 (see also Mineral Concentrates schedule)

This schedule shall only apply to cargoes that would fall under Packing Group (PG) III as specified in the IMDG Code if they were carried in a packaged form.

Description

Mineral concentrates are refined ores in which the valuable components have been enriched by eliminating the bulk of waste materials. Generally the particle size is small, although agglomerates sometimes exist in concentrates which have not been freshly produced.

The most common concentrates in this category are: zinc concentrates, lead concentrates, copper concentrates and low grade middling concentrates.

Characteristics

Angle of repose	Bulk density (kg/m ³)	Stowage factor (m ³ /t)
Not applicable	1,700 to 3,230	0.31 to 0.59
Size	Class	Group
Various	8*	A and B

*This material may also meet MHB criteria of self-heating solids and/or solids that evolve toxic gas when wet.

Hazard

This cargo may liquefy if shipped at a moisture content in excess of its Transportable Moisture Limit (TML). See sections 7 and 8 of this Code.

Some sulphide concentrates are liable to oxidation and may have a tendency to self-heat, with associated oxygen depletion and emission of toxic fumes. Moisture in the cargo will form sulphurous acid which is corrosive to steel.

Stowage & Segregation

Unless determined by the competent authority, segregation as required for class 4.2 and Class 8 materials.

"Separated from" foodstuffs.

Hold cleanliness

Clean and dry as relevant to the hazards of the cargo.

Weather precautions

When this cargo is carried in a ship other than a ship complying with the requirements in subsection 7.3.2 of this Code, the following provisions shall be complied with:

- .1 the moisture content of the cargo shall be kept less than its TML during loading operations and the voyage;
- .2 unless expressly provided otherwise in this individual schedule, the cargo shall not be handled during precipitation;
- .3 unless expressly provided otherwise in this schedule, during handling of the cargo, all non-working hatches of the cargo spaces into which the cargo is loaded or to be loaded shall be closed;
- .4 the cargo may be handled during precipitation under the conditions stated in the procedures required in subsection 4.3.3 of this Code; and
- .5 the cargo in a cargo space may be discharged during precipitation provided that the total amount of the cargo in the cargo space is to be discharged in the port.

Loading

Trim in accordance with the relevant provisions required under sections 4 and 5 of this Code.

When the stowage factor of this cargo is equal or less than 0.56 m³/t, the tank top may be overstressed unless the cargo is evenly spread across the tank top to equalize the weight distribution. Due consideration shall be given to ensure that the tank top is not overstressed during the voyage and during loading by a pile of the cargo forming.

Precautions

Entry into the cargo space for this cargo shall not be permitted until the space has been ventilated and the atmosphere tested for concentration of oxygen*. Appropriate precautions shall be taken to protect machinery and accommodation spaces from the dust of this cargo. Bilge wells shall be clean, dry and covered as appropriate, to prevent ingress of the cargo.

Bilge system of a cargo space to which this cargo is to be loaded shall be tested to ensure it is working. Persons who may be exposed to the dust of the cargo shall wear gloves, goggles or other equivalent dust eye-protection and dust filter masks. Those persons shall wear protective clothing, as necessary.

When a Metal Sulphide Concentrate is considered as presenting a low fire-risk, the carriage of such cargo on a ship not fitted with a fixed gas fire-extinguishing system shall be subject to the Administration's authorization as provided by SOLAS regulation II-2/10.7.1.4.

Ventilation

The cargo shall not be ventilated during the voyage.

Carriage

The appearance of the surface of the cargo shall be checked regularly during the voyage. If free water above the cargo or fluid state of the cargo is observed during the voyage, the master shall take appropriate action to prevent cargo shifting and potential capsizing of the ship, and give consideration to seeking emergency entry into a place of refuge.

For quantitative measurements of oxygen and toxic fumes liable to be evolved by the cargo, suitable detectors for each gas and fume or combination of these shall be on board while this cargo is carried. The detectors shall be suitable for use in an atmosphere without oxygen.

The concentrations of these gases in the cargo spaces carrying this cargo shall be measured regularly during voyage, and the results of the measurements shall be recorded and kept on board.

Discharge

No special requirements.

Clean-up

Ensure that all residues are washed away and the holds thoroughly dried. Wet dust or residues will form corrosive sulphurous acid, which is dangerous to personnel and will corrode steel.

Emergency procedures

<p>Special emergency equipment to be carried</p> <p>Protective clothing (gloves, boots, coveralls, headgear). Self-contained breathing apparatus.</p>
<p>Emergency procedures</p> <p>Wear protective clothing and self-contained breathing apparatus.</p> <p>Emergency action in the event of fire</p> <p>Batten down; use ship's fixed firefighting installation, if fitted. Exclusion of air may be sufficient to control the fire. Do not use water.</p> <p>Medical first aid</p> <p>Refer to the Medical First Aid Guide (MFAG), as amended.</p>

Remarks

Fire may be indicated by the smell of sulphur dioxide.

* Refer to the *Revised recommendations for entering enclosed spaces aboard ships*, adopted by the Organization by resolution A.1050(27)."

"MONOAMMONIUM PHOSPHATE (M.A.P.), MINERAL ENRICHED COATING

Description

This cargo is monoammonium phosphate (M.A.P.) with a mineral enriched coating. Odourless, brownish-grey granules. It is hygroscopic and can be very dusty.

Characteristics

Angle of repose	Bulk density (kg/m ³)	Stowage factor (m ³ /t)
35° to 40°	826 to 1,000	1.0 to 1.21
Size	Class	Group
Up to 4 mm	MHB (CR)	B

Hazard

This cargo has a pH of 4.5 and in the presence of moisture can be highly corrosive to eyes and skin. This cargo is non-combustible or has a low fire-risk.

This cargo will cake if wet.

This cargo will decompose burlap or canvas cloth covering bilge wells. Continuous carriage of this cargo may have detrimental structural effects over a long period of time.

Stowage & Segregation

No special requirements.

Hold cleanliness

Clean and dry as relevant to the hazards of the cargo.

Weather precautions

This cargo shall be kept as dry as practicable. This cargo shall not be handled during precipitation. During handling of this cargo all non-working hatches of the cargo spaces into which this cargo is loaded or to be loaded shall be closed.

Loading

Trim in accordance with the relevant provisions required under sections 4 and 5 of this Code.

Precautions

Appropriate precautions shall be taken to protect machinery and accommodation spaces from the dust of the cargo. Bilge wells of the cargo spaces shall be protected from ingress of the cargo. Due consideration shall be paid to protect equipment from the dust of the cargo. Persons who may be exposed to the dust of the cargo shall wear gloves, goggles or other equivalent dust eye-protection and dust filter masks. Those persons shall wear protective clothing, as necessary.

Ventilation

The cargo spaces carrying this cargo shall not be ventilated during voyage.

Carriage

Condensation in the cargo spaces carrying this cargo, sweating of this cargo and entering of water from hatch covers to the cargo spaces shall be checked regularly during the voyage. Due attention shall be paid to the sealing of hatches of the cargo spaces.

Discharge

This cargo is hygroscopic and may cake in overhangs, impairing safety during discharge. If this cargo has hardened, it shall be trimmed to avoid the formation of overhangs, as necessary.

Clean-up

After discharge of this cargo, particular attention shall be paid to bilge wells of the cargo spaces.

Emergency procedures

<p style="text-align: center;">Special emergency equipment to be carried Protective clothing (gloves, boots, coveralls, headgear). Self-contained breathing apparatus.</p>
<p style="text-align: center;">Emergency procedures Wear protective clothing and self-contained breathing apparatus.</p> <p style="text-align: center;">Emergency action in the event of fire Batten down; use ship's fixed firefighting installation, if fitted.</p> <p style="text-align: center;">Medical first aid Refer to the Medical First Aid Guide (MFAG), as amended.</p>

"MONOCALCIUMPHOSPHATE (MCP)

Description

The product consists of Monocalciumphosphate, monohydrate. Granulated. Light grey. Odourless.

Characteristics

Angle of repose	Bulk density (kg/m ³)	Stowage factor (m ³ /t)
Approximately 32°	900 to 1,100	0.91 to 1.11
Size	Class	Group
0.2 to 2 mm	MHB (CR)	A and B

Hazard

This cargo is non-combustible or has a low fire-risk.
Potential inhalation hazard and eye irritation from Monocalciumphosphate dust during handling, placement and transportation.

Stowage & segregation

No special requirements.

Hold cleanliness

No special requirements.

Weather precautions

When a cargo is carried in a ship other than a ship complying with the requirements in subsection 7.3.2 of this Code, the following provisions shall be complied with:

- .1 the moisture content of the cargo shall be kept less than its TML during loading operations and the voyage;
- .2 unless expressly provided otherwise in this individual schedule, the cargo shall not be handled during precipitation;
- .3 unless expressly provided otherwise in this individual schedule, during handling of the cargo, all non-working hatches of the cargo spaces into which the cargo is loaded or to be loaded shall be closed;
- .4 the cargo may be handled during precipitation under the conditions stated in the procedures required in subsection 4.3.3 of this Code; and
- .5 the cargo in a cargo space may be discharged during precipitation provided that the total amount of the cargo in the cargo space is to be discharged in the port.

Loading

Trim in accordance with the relevant provisions required under sections 4 and 5 of this Code.

Precautions

Appropriate precautions shall be taken to protect machinery and accommodation spaces from the dust of the cargo. Bilge wells of the cargo spaces shall be protected from ingress of the cargo. Due consideration shall be paid to protect equipment from the dust of the cargo. Persons who may be exposed to the dust of the cargo shall wear protective clothing, gloves, goggles or other equivalent dust eye-protection and dust filter masks, as necessary.

Ventilation

No special requirements.

Carriage

The appearance of the surface of this cargo shall be checked regularly during voyage. If free water above the cargo or fluid state of the cargo is observed during voyage, the master shall take appropriate actions to prevent cargo shifting and potential capsizing of the ship, and give consideration to seeking emergency entry into a place of refuge.

Discharge

No special requirements.

Clean-up

Avoid handling which creates dust.

Emergency procedures

<p>Special emergency equipment to be carried</p> <p>Protective clothing (gloves, boots, coveralls, headgear). Self-contained breathing apparatus.</p>
<p>Emergency procedures</p> <p>Wear protective clothing and self-contained breathing apparatus.</p> <p>Emergency action in the event of fire</p> <p>Batten down; use ship's fixed firefighting installation, if fitted. Exclusion of air may be sufficient to control the fire.</p> <p>Medical first aid</p> <p>Refer to the Medical First Aid Guide (MFAG), as amended.</p>

"OLIVINE SAND

Description

Olivine sand is a naturally occurring mineral and the colour can be pale greenish-grey to brownish.

Characteristics

Angle of repose	Bulk density (kg/m ³)	Stowage factor (m ³ /t)
30° to 45°	1,600 to 1,900	0.53 to 0.63
Size	Class	Group
Up to 20 mm	Not applicable	A

Hazard

This cargo may liquefy if shipped at a moisture content in excess of its Transportable Moisture Limit (TML). See sections 7 and 8 of this Code.

This cargo is non-combustible or has a low fire-risk.

Stowage & segregation

No special requirements.

Hold cleanliness

No special requirements.

Weather precautions

When a cargo is carried in a ship other than a ship complying with the requirements in subsection 7.3.2 of this Code, the following provisions shall be complied with:

- .1 the moisture content of the cargo shall be kept less than its TML during loading operations and the voyage;
- .2 unless expressly provided otherwise in this individual schedule, the cargo shall not be handled during precipitation;

- .3 unless expressly provided otherwise in this individual schedule, during handling of the cargo, all non-working hatches of the cargo spaces into which the cargo is loaded or to be loaded shall be closed;
- .4 the cargo may be handled during precipitation under the conditions stated in the procedures required in paragraph 4.3.3 of this Code; and
- .5 the cargo in a cargo space may be discharged during precipitation provided that the total amount of the cargo in the cargo space is to be discharged in the port.

Loading

Trim in accordance with the relevant provisions required under sections 4 and 5 of this Code.

When the stowage factor of this cargo is equal to or less than 0.56 m³/t, the tank top may be overstressed unless the cargo is evenly spread across the tank top to equalize the weight distribution. Due consideration shall be given to ensure that the tank top is not overstressed during the voyage and during loading by a pile of the cargo.

Precautions

No special requirements.

Ventilation

No special requirements.

Carriage

The appearance of the surface of the cargo shall be checked regularly during the voyage. If free water above the cargo or fluid state of the cargo is observed during the voyage, the master shall take appropriate actions to prevent cargo shifting and potential capsizing of the ship, and give consideration to seeking emergency entry into a place of refuge.

Discharge

No special requirements.

Clean-up

No special requirements."

"OLIVINE GRANULAR AND GRAVEL AGGREGATE PRODUCTS

This schedule shall only apply to cargoes containing less than 5% of fine particles less than 0.5 mm.

Description

Olivine granular and gravel aggregate products are naturally occurring minerals and the colour can be pale greenish-grey to brownish.

Characteristics

Angle of repose	Bulk density (kg/m ³)	Stowage factor (m ³ /t)
30° to 45°	1,600 to 1,900	0.53 to 0.63
Size	Class	Group
Up to 100 mm	Not applicable	C

Hazard

No special hazards.
This cargo is non-combustible or has a low fire-risk.

Stowage & segregation

No special requirements.

Hold cleanliness

No special requirements.

Weather precautions

No special requirements.

Loading

Trim in accordance with the relevant provisions required under sections 4 and 5 of this Code.

When the stowage factor of this cargo is equal to or less than 0.56 m³/t, the tank top may be overstressed unless the cargo is evenly spread across the tank top to equalize the weight distribution. Due consideration shall be given to ensure that the tank top is not overstressed during the voyage and during loading by a pile of the cargo.

Precautions

No special requirements.

Ventilation

No special requirements.

Carriage

No special requirements.

Discharge

No special requirements.

Clean-up

No special requirements."

"SAND, MINERAL CONCENTRATE, RADIOACTIVE MATERIAL, LOW SPECIFIC ACTIVITY (LSA-I) UN 2912

Description

This cargo is generally a concentrate stream resulting from the processing of heavy mineral sands. Such mineral sand concentrates are characterized by their heavy bulk density and relatively fine grain size. This schedule includes concentrates of sands containing natural or depleted uranium and thorium, including metals, mixtures and compounds.

Abrasive. May be dusty. This cargo is cohesive if moisture content is above 1%.

Characteristics

Angle of repose	Bulk density (kg/m ³)	Stowage factor (m ³ /t)
Approximately 35°	2,200 to 3,225	0.31 to 0.45
Size	Class	Group
Fine Particles up to 2 mm	7*	A and B

* This material also meets MHB criteria of toxic solids and corrosive solids.

Hazard

This cargo may liquefy if shipped at a moisture content in excess of its Transportable Moisture Limit (TML). See sections 7 and 8 of this Code.

Low radiotoxicity.

May cause long-term health effects and skin irritation.

Prolonged and repeated exposure to silica dust can result in respiratory disease.

This cargo is non-combustible or has a low fire-risk.

Stowage & segregation

"Separated from" foodstuffs.

Hold cleanliness

Clean and dry as relevant to the hazards of the cargo.

Weather precautions

When a cargo is carried in a ship other than a ship complying with the requirements in subsection 7.3.2 of this Code, the following provisions shall be complied with:

- .1 the moisture content of the cargo shall be kept less than its TML during loading operations and the voyage;
- .2 unless expressly provided otherwise in this individual schedule, the cargo shall not be handled during precipitation;
- .3 unless expressly provided otherwise in this individual schedule, during handling of the cargo, all non-working hatches of the cargo spaces into which the cargo is loaded or to be loaded shall be closed;
- .4 the cargo may be handled during precipitation under the conditions stated in the procedures required in subsection 4.3.3 of this Code; and
- .5 the cargo in a cargo space may be discharged during precipitation provided that the total amount of the cargo in the cargo space is to be discharged in the port.

Loading

Trim in accordance with the relevant provisions required under sections 4 and 5 of this Code. As the density of the cargo is extremely high, the tank top may be overstressed unless the cargo is evenly spread across the tank top to equalize the weight distribution. Due consideration shall be paid to ensure that the tank top is not overstressed during voyage and during loading by a pile of the cargo.

Precautions

Personnel shall not be unnecessarily exposed to dust of this cargo. Persons who may be exposed to the dust of the cargo shall wear protective clothing, goggles or other equivalent dust eye-protection and facemasks. There shall be no leakage outside the cargo space in which this cargo is stowed.

Ventilation

The cargo spaces carrying this cargo shall not be ventilated during voyage.

Carriage

All instructions provided by the shipper shall be followed for the carriage of this cargo. The appearance of the surface of this cargo shall be checked regularly during voyage. If free water above the cargo or fluid state of the cargo is observed during voyage, the master shall take appropriate actions to prevent cargo shifting and potential capsize of the ship, and give consideration to seeking emergency entry into a place of refuge.

Discharge

All instructions provided by the shipper shall be followed for the discharge of this cargo.

Clean-up

Cargo spaces used for this cargo shall not be used for other goods until decontaminated. Refer to subsection 9.3.2.3 of this Code.

Emergency procedures

<p style="text-align: center;">Special emergency equipment to be carried Protective clothing (gloves, boots, coveralls, headgear). Self-contained breathing apparatus.</p>
<p style="text-align: center;">Emergency procedures Wear protective clothing and self-contained breathing apparatus.</p> <p style="text-align: center;">Emergency action in the event of fire Batten down; use ship's fixed firefighting installation, if fitted. Use water spray to control spread of dust, if necessary.</p> <p style="text-align: center;">Medical first aid Refer to the Medical First Aid Guide (MFAG), as amended.</p>

Remarks

Most materials are likely to be non-combustible. Speedily collect and isolate potentially contaminated equipment and cover. Seek expert advice."

"SILICOMANGANESE (carbo-thermic)

Description

This material is a result of a carbo-thermic reduction process. A ferroalloy comprising principally manganese and silicon, mainly used as a deoxidizer and alloying element in the steel-making process. Particles or lumps of metallic-silver to dark-grey colour metal.

Characteristics

Angle of repose	Bulk density (kg/m ³)	Stowage factor (m ³ /t)
Not applicable	3,100 to 4,000	0.25 to 0.32
Size	Class	Group
Fines up to 80 mm	Not applicable	C

Hazard

No special hazards.

This cargo is non-combustible or has a low fire-risk.

Stowage & segregation

"Separated from" acids, alkalis, oxidizing and reducing agents and foodstuffs.

Hold cleanliness

No special requirements.

Weather precautions

No special requirements.

Loading

Trim in accordance with the relevant provisions required under sections 4 and 5 of this Code. As the density of the cargo is extremely high, the tank top may be overstressed unless the cargo is evenly spread across the tank top to equalize the weight distribution. Due consideration shall be paid to ensure that the tank top is not overstressed during the voyage and during loading by a pile of the cargo.

Precautions

No special requirements.

Ventilation

No special requirements.

Carriage

No special requirements.

Discharge

No special requirements.

Clean-up

No special requirements."

"SUGARCANE BIOMASS PELLETS

Description

Sugarcane Biomass Pellets are light blonde to chocolate brown in colour; very hard and cannot be easily squashed. Sugarcane Biomass Pellets are made of bagasse, straw and leaves left over from industrial and agricultural activities. Normally there are no additives or binders blended into the pellet. This schedule is also applicable to Sugarcane Biomass Pellets produced with the use of up to 2% of oxide-based mineral additives such as calcium, magnesium and aluminium oxides. The raw material is fragmented, dried and extruded into pellet form. The raw material is compressed to approximately one-third of its original volume and the finished Sugarcane Biomass Pellets typically have a moisture content of 6 to 10%.

Characteristics

Angle of repose	Bulk density (Kg/m ³)	Stowage factor (m ³ /t)
Approximately 30°	600 to 700	1.43 to 1.67
Size	Class	Group
Cylindrical with Diameter: 6 to 12 mm. Length: 10 to 50 mm.	MHB (CB, WT, WF and OH)	B

Hazard

Shipments are subject to oxidation leading to depletion of oxygen and increase of carbon monoxide and carbon dioxide in cargo and communicating spaces (also see Weather precautions).

Swelling occurs if exposed to moisture. Sugarcane Biomass Pellets may ferment over time if moisture content is over 15% leading to generation of asphyxiating and flammable gases which may cause spontaneous combustion. Handling of Sugarcane Biomass Pellets may cause dust to develop. Risk of explosion at high dust concentration.

Stowage & segregation

Segregation as required for class 4.1 materials.

Hold cleanliness

Clean and dry as relevant to the hazards of the cargo.

Weather precautions

This cargo shall be kept as dry as practicable. This cargo shall not be handled during precipitation. During handling of this cargo all non-working hatches of the cargo spaces into which this cargo is loaded or to be loaded shall be closed. There is a high risk of renewed oxygen depletion and carbon monoxide formation in previously ventilated adjacent spaces after closure of the hatch covers.

Loading

Trim in accordance with the relevant provisions required under sections 4 and 5 of this Code.

Precautions

Entry of personnel into the cargo spaces containing this cargo or the connecting spaces shall not be permitted until tests have been carried out and it has been established that the oxygen content and carbon monoxide levels have been restored to the following levels: oxygen 21% and carbon monoxide <100 ppm.* Close or direct contact of this cargo and cargo hold lighting such as hot halogen lamps shall be avoided. Fuses to such lights shall be removed or secured while this cargo is present in the cargo space. Precautions shall be taken to prevent generation of high concentrations of dust during handling and cleaning of this cargo.

Ventilation

Cargo spaces carrying this cargo shall not be ventilated during voyage. Ventilation of enclosed spaces adjacent to a cargo hold before entry may be necessary even if these spaces are apparently sealed from the cargo hold.

Carriage

Hatches of the cargo spaces carrying this cargo shall be weathertight to prevent the ingress of water.

Discharge

No special requirements.

Clean-up

No special requirements.

Emergency Procedures

<p>Special emergency equipment to be carried Self-contained breathing apparatus and combined or individual oxygen and carbon monoxide meters should be available.</p>
<p>Emergency procedures Nil</p>
<p>Emergency action in the event of fire Batten down; use ship's fixed firefighting installation, if fitted. Exclusion of air may be sufficient to control fire. Extinguish fire with carbon dioxide, foam or water.</p>
<p>Medical first aid Refer to the Medical First Aid Guide (MFAG), as amended.</p>

* Refer to the *Revised recommendations for entering enclosed spaces aboard ships*, adopted by the Organization by resolution A.1050(27)."

"SYNTHETIC CALCIUM FLUORIDE

Description

Odourless white-light brown material containing up to 70-80% calcium fluoride, 5-10% aluminium fluoride and 10-20% silicon dioxide.

The product consists of large particles and lumps which may break up during transport generating powder.

The product is insoluble in water.

Characteristics

Angle of repose	Bulk density (kg/m3)	Stowage factor (m3/t)
Not applicable	700 to 900	1.11 to 1.43
Size	Class	Group
Up to 30 mm	Not applicable	A

Hazard

This cargo may liquefy if shipped at a moisture content in excess of its Transportable Moisture Limit (TML). See sections 7 and 8 of this Code.

This cargo is non-combustible or has a low fire-risk.

Stowage & segregation

"Separated from" hydrofluoric acid, chlorine fluoride, manganese fluoride and oxygen difluoride.

Hold cleanliness

No special requirements.

Weather precautions

When a cargo is carried in a ship other than a ship complying with the requirements in subsection 7.3.2 of this Code, the following provisions shall be complied with:

- .1 the moisture content of the cargo shall be kept less than its TML during loading operations and the voyage;
- .2 unless expressly provided otherwise in this individual schedule, the cargo shall not be handled during precipitation;
- .3 unless expressly provided otherwise in this individual schedule, during handling of the cargo, all non-working hatches of the cargo spaces into which the cargo is loaded or to be loaded shall be closed;
- .4 the cargo may be handled during precipitation under the conditions stated in the procedures required in subsection 4.3.3 of this Code; and
- .5 the cargo in a cargo space may be discharged during precipitation provided that the total amount of the cargo in the cargo space is to be discharged in the port.

Loading

Trim in accordance with the relevant provisions required under sections 4 and 5 of this Code.

Precautions

Appropriate precautions shall be taken to protect machinery and accommodation spaces from the dust of the cargo. Bilge wells of the cargo spaces shall be protected from ingress of the cargo. Due consideration shall be paid to protect equipment from the dust of the cargo.

Ventilation

No special requirements.

Carriage

The appearance of the surface of the cargo shall be checked regularly during the voyage. If free water above the cargo or fluid state of the cargo is observed during the voyage, the master shall take appropriate action to prevent cargo shifting and potential capsize of the ship, and give consideration to seeking emergency entry into a place of refuge.

Discharge

No special requirements.

Clean-up

No special requirements."

"SYNTHETIC SILICON DIOXIDE

Description:

Odourless white powder containing up to 85% silicon dioxide, about 7% aluminium fluoride and up to 8% crystal water in dry weight.

The product has very low solubility in water.

Characteristics:

Angle of repose	Bulk density (kg/m3)	Stowage factor (m3/t)
Approximately 40°	300 to 500	2.00 to 3.33
Size	Class	Group
Up to 0.1 mm	Not applicable	A

Hazard

This cargo may liquefy if shipped at a moisture content in excess of its Transportable Moisture Limit (TML). See sections 7 and 8 of this Code.

This cargo is non-combustible or has a low fire-risk.

Stowage & segregation

"Separated from" hydrofluoric acid, chlorine fluoride, manganese fluoride and oxygen difluoride.

Hold cleanliness

No special requirements.

Weather precautions

When a cargo is carried in a ship other than a ship complying with the requirements in subsection 7.3.2 of this Code, the following provisions shall be complied with:

- .1 the moisture content of the cargo shall be kept less than its TML during loading operations and the voyage;
- .2 unless expressly provided otherwise in this individual schedule, the cargo shall not be handled during precipitation;
- .3 unless expressly provided otherwise in this individual schedule, during handling of the cargo, all non-working hatches of the cargo spaces into which the cargo is loaded or to be loaded shall be closed;
- .4 the cargo may be handled during precipitation under the conditions stated in the procedures required in subsection 4.3.3 of this Code; and
- .5 the cargo in a cargo space may be discharged during precipitation provided that the total amount of the cargo in the cargo space is to be discharged in the port.

Loading

Trim in accordance with the relevant provisions required under sections 4 and 5 of this Code.

Precautions

Appropriate precautions shall be taken to protect machinery and accommodation spaces from the dust of the cargo. Bilge wells of the cargo spaces shall be protected from ingress of the cargo.

Due consideration shall be paid to protect equipment from the dust of the cargo.

Ventilation

No special requirements.

Carriage

The appearance of the surface of the cargo shall be checked regularly during the voyage. If free water above the cargo or fluid state of the cargo is observed during the voyage, the master shall take appropriate action to prevent cargo shifting and potential capsize of the ship, and give consideration to seeking emergency entry into a place of refuge.

Discharge

No special requirements.

Clean-up

No special requirements."

"TITANOMAGNETITE SAND

Description

Titanomagnetite Sand has a nominal iron content of 57%.

Characteristics

Angle of repose	Bulk density (kg/m3)	Stowage factor (m3/t)
Not Applicable	2,740 to 2,820	0.35 to 0.36
Size	Class	Group
Up to 0.4 mm	Not applicable	A

Hazard

This cargo may liquefy if shipped at a moisture content in excess of its Transportable Moisture Limit (TML). See sections 7 and 8 of this Code.

This cargo is non-combustible or has a low fire-risk.

Stowage & Segregation

No special requirements.

Hold Cleanliness

No special requirements.

Weather Precautions

When a cargo is carried in a ship other than a ship complying with the requirements in subsection 7.3.2 of this Code, the following provisions shall be complied with:

- .1 the moisture content of the cargo shall be kept less than its TML during loading operations and the voyage;
- .2 unless expressly provided otherwise in this individual schedule, the cargo shall not be handled during precipitation;
- .3 unless expressly provided otherwise in this individual schedule, during handling of the cargo, all non-working hatches of the cargo spaces into which the cargo is loaded or to be loaded shall be closed;
- .4 the cargo may be handled during precipitation under the conditions stated in the procedures required in paragraph 4.3.3 of this Code; and
- .5 the cargo in a cargo space may be discharged during precipitation provided that the total amount of the cargo in the cargo space is to be discharged in the port.

Loading

Cargo shall be trimmed to avoid steep surfaces of cargo that could collapse during voyage. As the density of the cargo is extremely high, the tank top may be overstressed unless the cargo is evenly spread across the tank top to equalize the weight distribution. Due consideration shall be given to ensure that the tank top is not overstressed during the voyage and during loading by a pile of the cargo.

Precautions

Bilge wells shall be clean, dry and covered to prevent ingress of cargo. Bilge covers shall not significantly degrade the capacity or operation of the bilge system. Bilges shall be sounded and pumped out, as necessary, throughout the voyage.

Ventilation

No special requirements.

Carriage

Unless this cargo is carried in a ship complying with the requirements in subsection 7.3.2 of this Code, the appearance of the surface of the cargo shall be checked regularly during the voyage. If free water above the cargo or fluid state of the cargo is observed during the voyage, the master shall take appropriate action to prevent cargo shifting and potential capsizing of the ship, and give consideration to seeking emergency entry into a place of refuge.

Discharge

No special requirements.

Clean-up

After discharge of this cargo, the bilge wells shall be checked and any blockage shall be removed. If the ship is fitted with a de-watering system of the cargo spaces, after discharge of this cargo, the system shall be checked and any blockage in the systems shall be removed."

APPENDIX 2

Laboratory test procedures, associated apparatus and standards

1 Test procedures for materials which may liquefy and associated apparatus

192 In the beginning of the first sentence, replace the term "Three" with "Five". After the sentence "As each method has its advantages, the selection of the test method should be determined by local practices or by the appropriate authorities", add two new sub-paragraphs as follows:

- .4 Modified Proctor/Fagerberg test procedure for Iron Ore Fines; and
- .5 Modified Proctor/Fagerberg test procedure for Coal.

193 Add a new paragraph 1.5 as follows:

"1.5 Modified Proctor/Fagerberg test procedure for Coal

1.5.1 Scope

This procedure details the laboratory determination of Transportable Moisture Limit (TML) for coals up to a nominal top size of 50 mm. The procedure is based on a modification of the Proctor/Fagerberg test described in section 1.3 of this appendix.

Key modifications to the original test procedure contained in section 1.3 of this appendix are:

- .1 Sample preparation to facilitate the testing of 0 x 50 mm coal through reconstitution to -25 mm;
- .2 Use of a 150 mm diameter compaction cylinder; and
- .3 Sample compaction using a hammer equivalent to the Proctor/Fagerberg "D" energy hammer.

The Transportable Moisture Limit is the moisture content corresponding to the intersection of the 70% degree saturation curve and the test sample compaction curve.

In the case of coals where moisture freely drains from the sample such that the test sample compaction curve does not extend to or beyond 70% saturation, the test is taken to indicate a cargo where water passes through the spaces between particles and there is no increase in pore water pressure. Therefore, the cargo is not liable to liquefy. (See subsection 7.2.2 of this Code).

The procedure commences with a drum of coal containing a sample of not less than 170 kg delivered to the testing laboratory and terminates with the laboratory reporting the test result for the coal. Details of the sample collection process are excluded from this procedure. However it is important that the sample accurately represents the size distribution of the cargo and reference should be made to the normative reference list below.

1.5.2 Normative references

The following documents are referenced in this procedure. For dated references, only the cited edition applies. For undated references, the latest edition of the referenced document (including any amendments) applies.

- AS 1289.3.5.1:2006, Methods of testing soils for engineering purposes. Method 3.5.1: Soil classification tests – Determination of the soil particle density of a soil – Standard method;
- ISO 589:2008, Hard Coal – Determination of total moisture;
- ISO 3319-2:2013, Test requirements and testing – Part 2: Test sieves of perforated metal plate; and
- ISO 13909-4:2001, Hard coal and coke – Mechanical sampling – Part 4 – Coal – Preparation of test samples.

1.5.3 Definitions

(1) Transportable Moisture Limit (TML)

The Transportable Moisture Limit (TML) of a cargo which may liquefy means the maximum moisture content of the cargo which is considered safe for carriage in a ship not complying with the requirements in subsection 7.3.2 of this Code.

(2) Test outcomes

The Transportable Moisture Limit determined by this procedure is the moisture content corresponding to the intersection of the 70% degree saturation curve and the test sample compaction curve. This is also referred to as the PFD70 value (Proctor/Fagerberg – D energy hammer – 70% saturation).

Where moisture freely drains from the sample or the cylindrical mould at moisture content such that the test sample compaction curve does not extend to or beyond 70% saturation (as described in paragraph 1.5.5.3(4)), the test is taken to indicate a cargo where water passes through the spaces between particles and there is no increase in pore water pressure. Therefore, the cargo is not liable to liquefy. (See subsection 7.2.2 of this Code).

(3) Optimum Moisture Content (OMC)

The Optimum Moisture Content is the moisture content corresponding to the maximum compaction (maximum dry density) under the specified compaction condition.

(4) Gross water content or total moisture (W^1)

The moisture content of a sample is calculated as the mass of water divided by the total mass of solids plus water and is referred to as either the gross water content or the total moisture content. Gross water content is to be determined using the method for determining total moisture defined in the standard ISO 589:2008.

1.5.4 Determination of the TML of blends of two or more coals

In circumstances where a shipper intends to load a cargo consisting of a blend of two or more coals, the shipper may:

- .1 determine the TML of the blend by direct application of the test method described within this procedure to a representative sample of the blended product; or
- .2 declare the TML of the blend based on TML determinations on each of the component coals.
 - .1 Where all component coals in the blend are known to be Group A and B coals:
 - .1.1 The blended cargo should be declared as Group A and B, and
 - .1.2 The TML of the blended cargo should be determined as the lowest TML value of any of the component coals.
 - .2 Where a Group A and B cargo component is blended with a coal which is designated as Group B only:
 - .2.1 The blended cargo should be declared as Group A and B, and
 - .2.2 The TML should be taken as the lowest TML of the Group A and B component coals contained within the blend.

- .3 Where all component coals are determined to be Group B only coals, the blended cargo may be declared as a Group B only cargo.

1.5.5 Modified Proctor/Fagerberg test procedure for coal

1.5.5.1 Apparatus

(1) Work area

The work area should be located where the samples are protected from excessive temperatures, air currents and humidity variations. All samples should be stored in suitable sample containers, including plastic sample bags, and the containers should be sealed.

(2) Standard sieves

Square aperture laboratory sieves of 16 mm and 25 mm aperture as nominated in ISO 3319-2:2013 are required for reconstitution of the sample at 25 mm top size. A 2.36 mm sieve is required for generation of + 2.36 mm and –2.36 mm fractions for particle density determination. Optionally a 2 mm sieve may be used for this purpose.

(3) Proctor/Fagerberg apparatus

The Proctor/Fagerberg apparatus consists of a cylindrical stainless steel mould having 150 mm diameter and 120 mm height with a removable extension piece (the compaction cylinder) and a compaction tool guided by a pipe at its lower end (the compaction hammer), which are shown in figure 1.5.1. A schematic diagram of the Proctor/Fagerberg apparatus is shown in figure 1.5.2 with dimensions and tolerances indicated in table 1.5.5.



Figure 1.5.1 Example of Proctor/Fagerberg test apparatus, hammer and hammer guide

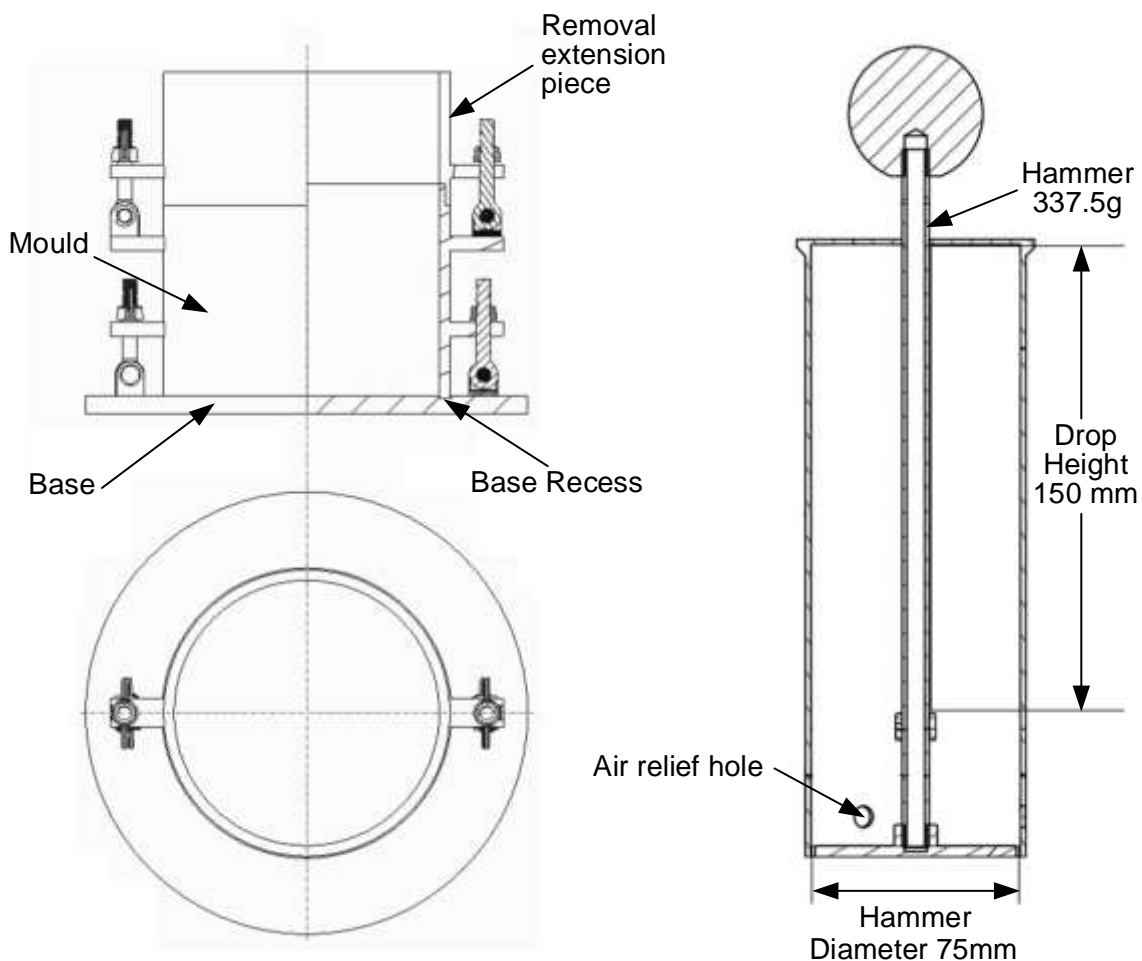

Compaction Cylinder

Compaction Hammer

Figure 1.5.2 Schematic of a Proctor/Fagerberg apparatus

(4) Compaction hammer

A "D" energy equivalent compaction hammer is used for this test. Dimensions are shown in figure 1.5.2 and table 1.5.5. (Note: the compaction hammer has been modified to match the mould used.)

(5) Drying oven

The drying oven should be ventilated, with forced circulation of air or inert gas, typically with a stainless steel interior and capable of maintaining a temperature within the range of $105^{\circ}\text{C} \pm 5^{\circ}\text{C}$.

(6) Weighing balance

The weighing balance should be capable of weighing the sample and the container, as received, with an accuracy of better than ± 5 g.

(7) Pycnometer

Water pycnometry equipment is used to determine the density of the full sized coal (non-crushed) in accordance with AS 1289.3.5.1:2006. Specific equipment required is as follows:

- a conical flask or density bottle of 250 ml capacity;
- a vacuum desiccator or other vacuum equipment;
- a drying oven set to 105°C to 110°C;
- balances – one with ± 0.05 g accuracy and the second with ± 1 g accuracy;
- a 0°C to 100°C thermometer;
- a 2.36 mm sieve (as noted in paragraph 1.5.5.1(2))
- a vacuum source;
- a water bath set at 60°C;
- distilled, demineralized or deionized water;
- a wash bottle containing water;
- a wire basket to hold the + 2.36 mm sample;
- a container filled with water to hold the wire basket without interference; and
- a scale to weigh the basket both suspended in water and drained.

(8) Containers for hand mixing and sample preparation

Sufficient heavy-duty plastic buckets with lids of not less than 10 litres capacity are required for storage and handling. Heavy-duty plastic bags (200 micron thick or greater) are required for storage and hand mixing of samples.

(9) Flat scraping device

A thin steel scraper is required for separating the remnant sample formed in the extension piece lying above the top level of the mould. For ease of use, the scraper should have dimensions of 160 mm wide, 200 mm long and 3 mm to 5 mm thick, such as that shown in figure 1.5.3.

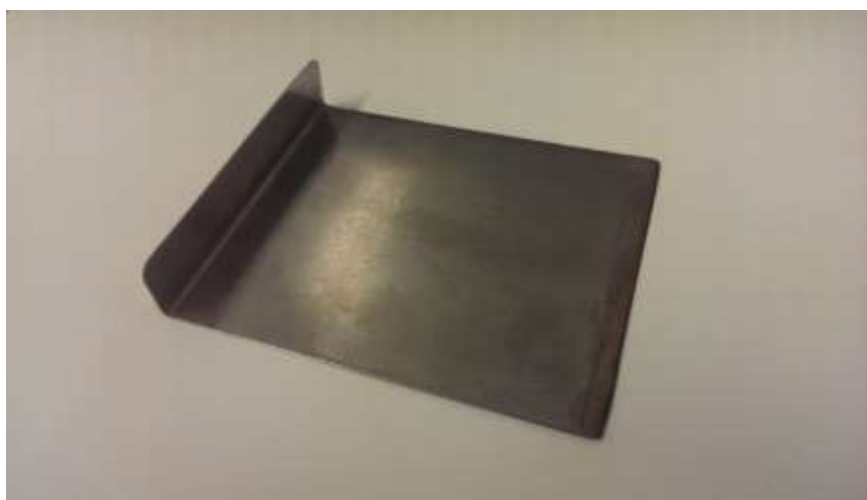

Figure 1.5.3 Typical scraping device

(10) Drying trays

Drying trays or pans should have a smooth surface, be free from contamination and heat resistant, for example stainless steel or enamel. Dimensions should be suitable to fit in the drying oven and ensure that the total sample can be contained at a loading of about 1 g/cm² of surface area.

(11) Spray bottle

A suitable plastic bottle is required to add a mist spray of water to the sample.

(12) Gloves

Heat resistant gloves are required for removal of hot trays and dishes.

(13) Sample divider

A suitable sample divider as specified in ISO 13909-4:2001 is required for sub-sampling the primary sample and blending the reconstituted sample for testing.

1.5.5.2 Sampling and sample preparation

(1) General

This procedure commences with receipt of sample of not less than 170 kg, sealed in a heavy duty (200 micron thick) plastic bag and contained in a suitable drum (e.g. 220 litres). This packaging ensures the sample does not dry prior to TML determination.

(2) Sample preparation

Representative samples are required that have been obtained using ISO 13909-4:2001 and if required may be partially air dried or partially dried at a temperature of 40°C or less to reduce the water content to a starting point suitable for dry sieving the coal with minimal fines adhering to the oversize fraction. For this purpose, samples should not be dried below 6% total moisture. The representative subsamples for the test should not be fully dried, except in the case of gross water content determination.

(2.1) Sample homogenization and division

Take the as-received sample and divide into individual sub-samples using a sample dividing apparatus as specified in ISO 13909-4:2001. Place these subsamples into heavy-duty plastic bags.

(2.2) Reconstituted sample preparation procedure

When the sample contains particles above 25 mm, the reconstitution process below should be applied.

In this process, particles above 25 mm are removed from the sample and replaced by an equivalent mass of particles in the range 16 mm to 25 mm. Through this process a final reconstituted sample of sufficient mass for TML testing is generated which contains a maximum particle size of 25 mm.

One of two methods may be selected to generate the reconstituted sample:

- .1 Split the entire as-received sample and then reconstitute; or
- .2 Scalping off particles above 25 mm and substituting particles between 16 mm and 25 mm from a separate sub-sample.

Method 1 Splitting the full as received sample and reconstitution

- (i) Take the full as-received sample;
- (ii) Screen at 25 mm, 16 mm and 2.36 mm. If a 2.36 mm screen is not available, a 2 mm screen may be used;
- (iii) Weigh each of the four size fractions and calculate the percentage represented by each size fraction;
- (iv) Sub-divide from each size fraction below 25 mm the required mass to create a 25 kg reconstituted sample using the sample size components specified in table 1.5.1:

Table 1.5.1 Reconstitution size proportions (Method 1)

Size fraction	Quantity
-2.36 mm (or -2 mm)	percentage of this fraction in the original sample
2.36 mm (or 2 mm) to 16 mm	percentage of this fraction
16 mm to 25 mm	percentage of this fraction plus the percentage of + 25 mm coal

- (v) Combine each size fraction;
- (vi) Fully mix the reconstituted sample;
- (vii) Split the sample into approximately eight representative sub-samples and place each into a heavy duty plastic bag. These bags now contain the sample for Proctor/Fagerberg testing.
- (viii) A sample of particles passing a 2.36 mm screen (or 2.0 mm if 2.36 mm is not available) is required for particle density pycnometry.

Method 2 Scalping particles above 25 mm and replacement with 16 mm to 25 mm particles

This method is described in figure 1.5.4 and table 1.5.2. The reconstitution process commences where the coal is initially sieved into particle sizes larger than 25 mm and smaller than 25 mm. Coal particles in the size range of 16 mm to 25 mm are extracted from separate subsamples and reconstituted back into the original -25 mm screened coal based on a mass equivalent to the + 25 mm sized coal removed from the initial sample to provide a final reconstituted sample of sufficient mass for TML testing.

Coal Sample

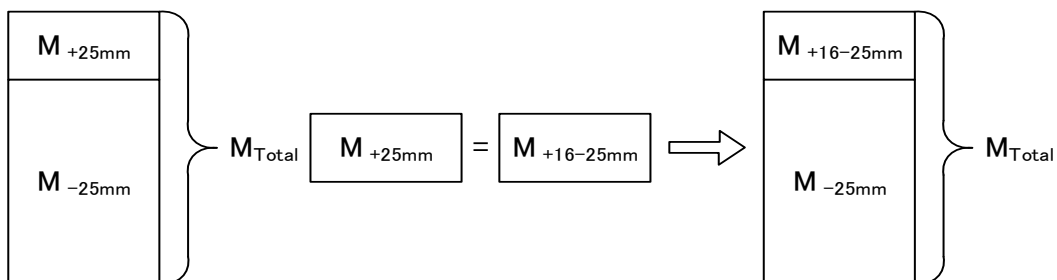

Figure 1.5.4 Overview of sample reconstitution (Method 2)

Table 1.5.2 Sample reconstitution (Method 2)

Step	Example
a) Generate a sample of approximately 25 kg which is sufficient to complete approximately eight Proctor/Fagerberg tests.	Assumes each subsample bag contains 8 kg to 10 kg.
b) Screen this sample at 25 mm, ensuring minimal adhering fines on the +25 mm fraction. Weigh the +25 mm coal.	For a coal containing 20% +25 mm material, approximately 5 kg of initial sample is removed.
c) Create sufficient 16 mm to 25 mm coal by screening one or more further subsample bags of coal at 16 mm and 25 mm.	In the above example, 5 kg of 16 mm to 25 mm coal is required.
d) Extract an amount of 16 mm to 25 mm coal of mass equal to the mass of +25 mm removed in step b) within ± 0.05 kg using a rotary sample divider or similar device, recombining sector trays as required to obtain the required mass.	5 kg in the above case.
e) Add the mass of 16 mm to 25 mm coal from step d) to the -25 mm coal from step b). Blend and divide into approximately eight test portions using a rotary sample divider or similar device.	
f) Place each reconstituted test portion in heavy duty plastic bags, label and seal. These now become the test portions used for Proctor/Fagerberg testing.	Each bag should contain approximately 2.5 kg to 3 kg of reconstituted -25 mm coal.
g) Discard the +25 mm and -16 mm coal.	

(3) Initial moisture

Initial moisture is to be determined on a test portion from table 1.5.2 step e) using the method provided in ISO 589:2008. This moisture value provides a guide to the moisture steps required to develop the Proctor/Fagerberg compaction curve.

(4) Particle density measurement

In accordance with water pycnometer standard AS 1289.3.5.1:2006, measure the density of solids on the full size range (non-crushed) coal. The density of solids is used for determining the void ratio for plotting compaction curves. The recommended methodology is described below:

- (a) Generate a full particle size sample of approximately 10 kg, weigh and then screen the entire contents at 2.36 mm. If a 2.36 mm screen is not available, a 2 mm screen may be substituted. Record the following:
 - (i) The total mass of the material;
 - (ii) The mass of +2.36 mm material; and
 - (iii) The mass of -2.36 mm material.
- (b) Calculate the percentage of -2.36 mm coal in the sample.

- (c) Divide the +2.36 mm coal into two test portions using sample dividing apparatus as specified in ISO 13909-4:2001 such as a rotary sample divider. Place each test portion in a heavy duty plastic bag and label.
- (d) Divide the -2.36 mm coal into two test portions, place each test portion in a heavy duty plastic bag and label.
- (e) Determine the density of solids of the +2.36 mm fraction following the method described in Section 5.2 of AS 1289.3.5.1:2006. As noted in the standard, duplicate determinations are required.
- (f) Determine the density of solids of the -2.36 mm fraction using the method described in Section 5.1 of the above standard with the following clarifications:
 - (i) Use of 250 mm conical or pycnometry flasks is recommended.
 - (ii) From the sample bag pour 1 litre of coal into a beaker of known tare weight.
 - (iii) Weigh the 1 litre sample and calculate the approximate bulk density of the material.
 - (iv) Remove a portion of the sample (nominally a mass in kilograms of 0.18 x bulk density) and place into the flask, and complete the pycnometry analysis.
 - (v) A water bath temperature of 60°C is recommended.
- (g) Calculate the density of solids using the method in Section 6 of AS 1289.3.5.1:2006.

1.5.5.3 Test procedure

(1) Variables and definitions

The variables and definitions used in the determination of TML are summarized in table 1.5.3 with some key variables as illustrated in figure 1.5.5.

Table 1.5.3 Summary of variables and definitions

Variable	Unit	Symbol / value used in calculations
Mass of empty cylinder and base	g	A
Mass of cylinder, base and tamped test portion	g	B
Wet mass of test portion in the mould	g	$C = B - A$
Wet mass of test portion removed from the mould	g	C_1
Dry mass of test portion removed from the mould	g	D_1
Gross water content	%	W^1
Dry mass of test portion in the mould	g	D
Mass of water in the mould	g	E
Volume of cylinder	cm ³	V
Density of solids	g/cm ³	d
Density of water	g/cm ³	ρ_w

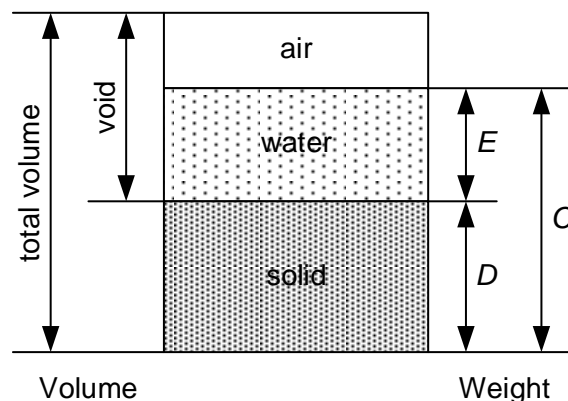

Figure 1.5.5 Illustration of key variables

(2) Establishment of the initial compaction point

The initial compaction point is obtained using the first test portion of the reconstituted material at the initial moisture content. For each compaction point determination, all steps in the procedure from packing the mould to weighing the mould and sample are to be completed at the same time without breaks. In any case, coal should not be left in the mould for longer than thirty minutes prior to weighing.

The test procedure is as follows:

- (a) Clean the mould, collar and base plate. Inspect and clean the hammer and ensure that it moves freely in the guide tube.
- (b) Determine the mass, A , of the empty cylinder, comprising the mould plus base plate.
- (c) Assemble the mould, collar and base plate and place the assembly on a stable bench.
- (d) Place approximately 0.5 litre (one fifth of the full 2.5 litres) of the test portion into the mould, level, and then tamp uniformly over the surface by dropping the hammer 25 times vertically through the full height of the guide pipe, moving the guide pipe to a new position after each drop. The required pattern for even compaction of each layer in the mould is shown in figure 1.5.6.
- (e) Repeat step (d) four more times so that there are 5 layers of material in the mould. Ensure that the compacted test portion with the final layer is above the top of the compaction mould whilst the extension piece is still attached.
- (f) When the last layer has been tamped, remove the extension piece taking care not to disturb the compacted test portion inside. Level the compacted test portion to the top of the mould using the flat scraping device, ensuring that any large particles that may hinder levelling of the test portion are removed and replaced with material contained in the extension piece and re-level. If any holes in the surface are still observed after levelling, they should be manually filled with finer material contained in the extension piece. Care should be taken to avoid any further compaction of the test portion.

- (g) Determine the mass, B , of the mould and compacted coal and then calculate the mass, C , of the wet test portion using the equation:

$$C = B - A \quad (1)$$

- (h) When the weight of the cylinder with the tamped test portion has been determined, remove the test portion from the mould, determine the mass of the wet test portion, C_1 , and dry the entire test portion in an oven at 105°C until constant mass is achieved. After drying, determine the weight, D_1 , of the dried test portion and then calculate the percentage gross water content, W^1 , as follows:

$$W^1 = (C_1 - D_1)/C_1 \times 100\% \quad (2)$$

- (i) Using the calculated gross water content, calculate the mass of the dry test portion in the mould, D , using the equation:

$$D = C - C \times W^1/100 \quad (3)$$

- (j) Calculate the mass, E , of water in the mould using the equation:

$$E = C - D \quad (4)$$

- (k) Discard the used coal sample. Coal from a previously compacted test portion should not be reused.

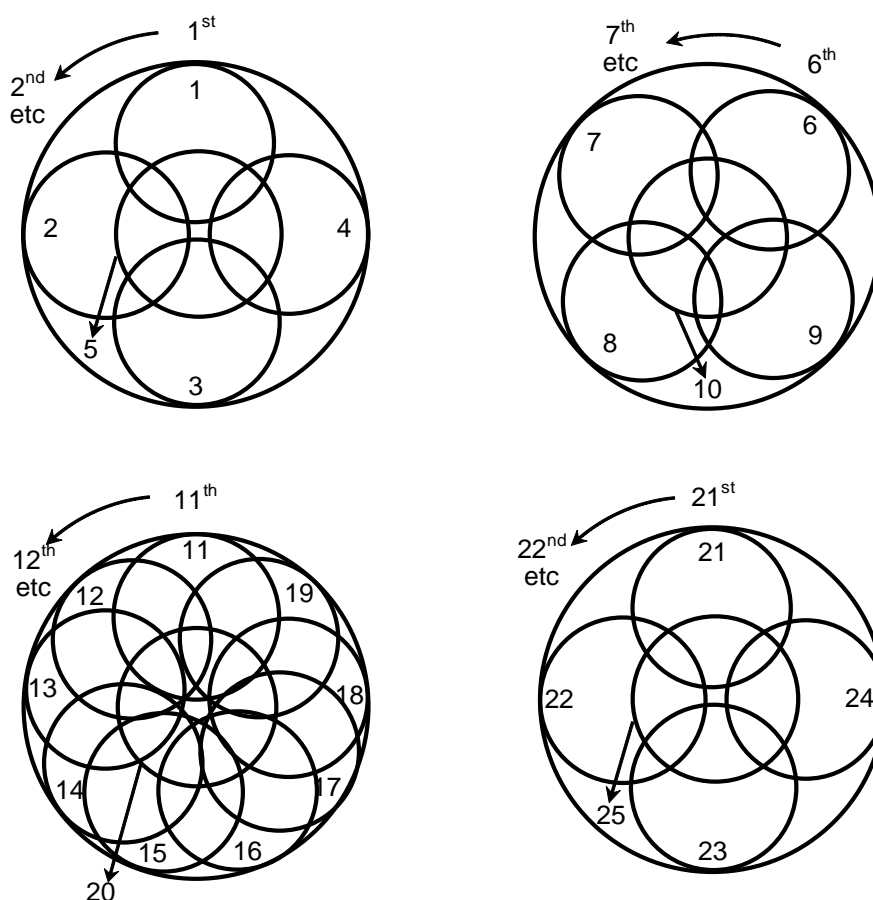

Figure 1.5.6 Recommended compaction patterns

(3) Establishment of complete compaction curve

The range of water contents should be adjusted so that partially dry to almost saturated test portions are obtained. Care should be taken to follow the precaution in paragraph 1.5.5.3(2) above regarding prompt completion of each point in the compaction curve.

The test procedure is as follows:

- (a) For each compaction test, a predetermined amount of water is added to the test portion (approximately 2.5 kg) in a heavy duty plastic bag. The water quantity added is that required to increase the moisture content to the target value for the next test. The water should be added as a mist spray to the surface of the individual test portions. The water at this point should be added slowly and in small quantities, as the introduction of large amounts of water may induce localized compaction behaviour.
- (b) After the calculated water addition, the test portion should then be mixed thoroughly in the plastic bag by sealing the bag and turning it over repeatedly for 5 minutes.
- (c) The test portion should then be allowed to equilibrate for a minimum of 12 hours prior to compaction testing.
- (d) Repeat steps (a) to (k) from paragraph 1.5.5.3(2).
- (e) Repeat the test between four and seven times using the other prepared test portions with different water contents to obtain at least five points on the compaction curve. The water contents should be chosen so that:
 - .1 at least one point corresponds to moisture content higher than the Optimum Moisture Content (OMC) or than the value corresponding to 70% of degree of saturation (S), in order to satisfactorily define the compaction curve; and
 - .2 at least one point corresponds to the degree of saturation (S) between 70% and 80%, in order to effectively assess the PFD70 value.

A point close to a degree of saturation (S) of 80% will also assist accurate assessment if the OMC is greater than 70%.

(4) Visual appearance of coal in the cylindrical mould

In order for the test to obtain a PFD70 value, all tests conducted at or below the PFD70 moisture value should have an even moisture distribution throughout the cylindrical mould.

Two examples of tests using samples of the same coal at different moisture contents are shown in figure 1.5.7. The left hand photograph shows a coal specimen at a relatively low degree of saturation. Note that the coal remains in place following removal of the collar. The right hand photograph shows a specimen near or possibly above 70% degree of saturation. Once again the coal remains in place following removal of the collar. Both tests provided valid points on the compaction curve.



Figure 1.5.7 Photographs showing valid tests for a partially saturated test portion (left) and a near fully saturated test portion (right)

Coals where water passes through the spaces between particles exhibit moisture migration within the Proctor/Fagerberg cylindrical mould. Moisture migration may take place when the degree of saturation of the specimen is less than 70%.

Evidence of moisture migration is from visual observation at the completion of each test as follows:

- .1 Moisture leakage from the base of the mould is evident as shown in figure 1.5.8; and
- .2 The portion above the top of the cylindrical mould appears unsaturated and the test portion maintains its structure without deformation or movement.

In this case, moisture migration has occurred and hence for this coal water passes through the spaces between particles.



Figure 1.5.8 Test showing water leakage from the base of the cylindrical mould indicating moisture migration

(5) Calculation of key parameters for determination of compaction curve

Carry out the following calculations for each compaction test:

d = density of solids, g/cm³ (t/m³) by pycnometry (see 1.5.5.2(4)).

γ = dry bulk density, g/cm³ (t/m³)
= D/V

e_v = net water content (percentage by volume)
= $(E/D) \times 100 \times d/\rho_w$

where ρ_w = density of water, g/cm³ (t/m³)

e = void ratio (volume of voids divided by volume of solids)
= $(d/\gamma) - 1$

S = degree of saturation (percentage by volume)
= e_v/e

W^1 = gross (total) water content (percentage by mass) (see 1.5.5.3(2)(h)).

(6) Presentation of compaction results

Record all the compaction test results in a suitable spreadsheet (such as that shown in table 1.5.4) and from this spreadsheet create a compaction curve as shown in figure 1.5.9 by plotting the calculated void ratio (e) for each compaction test on the ordinate against either the net or gross water content plotted on the abscissa.

The lines in figure 1.5.9 correspond to plots of void ratio (e) versus net water content (e_v) at 20%, 40%, 60%, 70%, 80% and 100% degree of saturation (S). These lines are calculated at five values of void ratio using the formulae in section 1.5.5.3(7). (Note: These lines corresponding to degree of saturation will be curved in the case of plotting gross water content on the abscissa.)

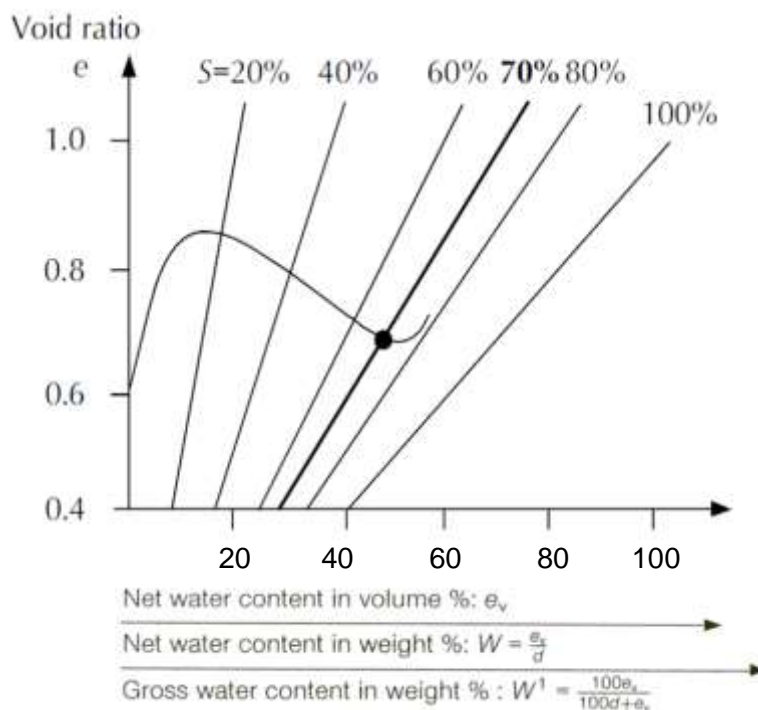

Figure 1.5.9 Typical compaction curve

(7) Sample compaction curve

An example of the results obtained when applying the Modified Proctor/Fagerberg test to a coal sample is provided in table 1.5.4, with the corresponding compaction curve and the 70% degree of saturation line plotted as described below.

The preferred approach to presenting the results is to plot the void ratio (e) against the gross water content (W^1) allowing moisture for any saturation level to be read directly from the plot as gross water content. This approach is shown in figure 1.5.10. The saturation lines are plotted according to the equation:

$$e = W^1 / (100 - W^1) \times 100 \times d / S$$

The intercept of the compaction curve with the 70% degree of saturation line in figure 1.5.10 occurs at a gross water content of 15.4%, which is the Transportable Moisture Limit (TML). For this example, the Optimum Moisture Content (OMC) occurs at a degree of saturation of about 85%.

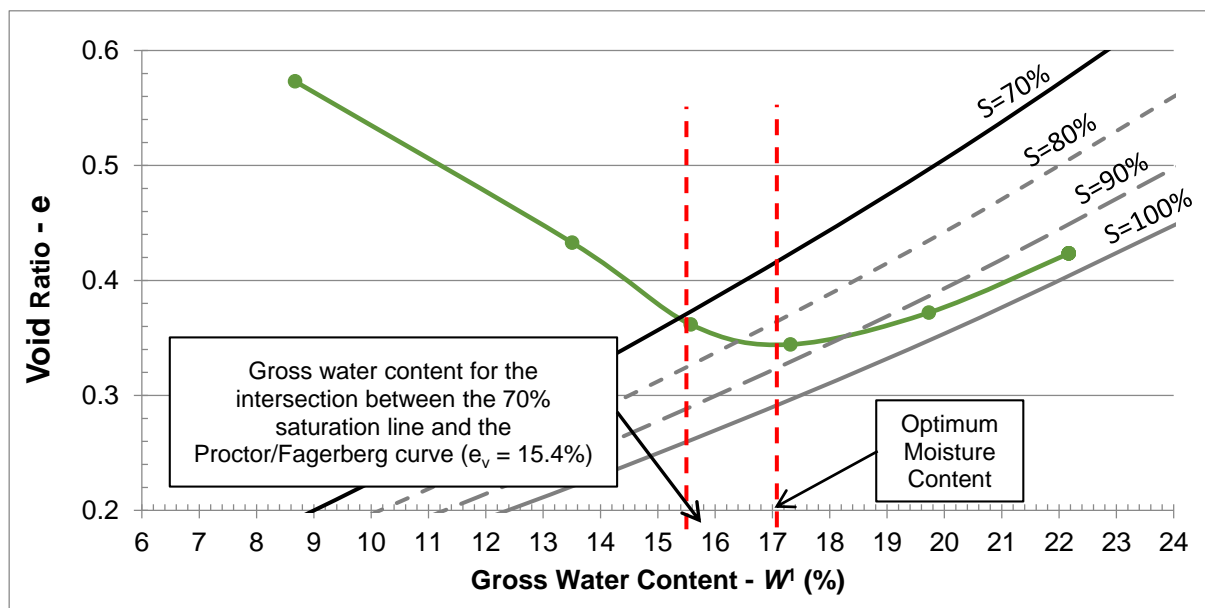

Figure 1.5.10 Example of a measured compaction curve for void ratio versus gross water content with the 70%, 80%, 90% and 100% degree of saturation lines plotted

(8) Determination of transportable moisture limit

(8.1) Determination of PFD70 moisture content

The PFD70 value is determined as the gross (total) water content corresponding to the intersection of the compaction curve and the line $S = 70\%$ saturation. The Optimum Moisture Content (OMC) is the gross (total) moisture content corresponding to the maximum compaction (maximum dry density and minimum void ratio) under the specified compaction condition.

The test procedure is applicable for determination of coal TML where the degree of saturation corresponding to the OMC of the coal is at or greater than 70%. Where the OMC lies below 70% degree of saturation, this test is not applicable for the specific coal and the PFD70 may overstate the TML. In such cases, the certificate of analysis should state that the OMC is below 70% saturation and the shipper should consult with an appropriate authority.

(8.2) Cases where the highest determinable point on the compaction curve lies below 70% saturation

In coals where there is visual evidence that water passes through the spaces between particles and the compaction curve does not extend to or beyond the 70% degree of saturation line, the coal is deemed to be free-draining and a TML value is not applicable. By reference to section 7.2.2 of this Code, such coals are cargoes which are not liable to liquefy, and hence are classified as Group B only.

1.5.6 Test report

The test report from application of the Modified Proctor/Fagerberg test procedure should include the following information:

- (a) Identification of the sample;

- (b) A unique reference to this test procedure;
- (c) Reference to the appropriate standard adopted for determining the density of the solids:
- (d) Either:
 - (i) The Transportable Moisture Limit (TML) of the sample, expressed as the gross water content as a percentage of the sample by mass;
 - (ii) The OMC lies below 70% degree of saturation and this test procedure is not applicable; or
 - (iii) A statement that the test indicated that water passes through the spaces between particles at moisture content below the value corresponding to 70% degree of saturation, and the coal is therefore Group B only.
- (e) The solids density d in g/cm^3 .

Table 1.5.4 Example of TML determination for a coal sample using the Modified Proctor/Fagerberg test procedure for coal

Date		Diameter of cylinder	150 mm
Product		Height of cylinder	120 mm
Sample		Volume of cylinder	2121 ml
Initial gross water content (%)	5.6	TML	15.4%
Density of solids	1416 kg/m ³		
Laboratory temperature	25°C	Size fraction	
Mass of mould (A)	7271 g	Operator	
Initial Dry density	899 kg/m ³	Tamper	337.5 g

Test number	Water added	Mass of mould + sample	Tray No.	Mass of tray	Mass of wet sample + tray	Mass of dry sample + tray	Measured gross water content	Gross water content	Net water content	Void ratio	Dry density	Degree of saturation	Wet bulk density	Mass of wet sample	Mass of dry sample	Mass of water
	(ml)	(g)		(g)	(g)	(g)	(%)	(%)	(%v)		(g/cm ³)	(%)	(g/cm ³)	(g)	(g)	(g)
		B						W^g	ev	e	γ	S		C	D	E
1	0.00	9360.00	T1	602.5	1656.8	1565.7	8.64	8.67	13.437	0.573	0.899	23.4	0.985	2089.0	1907.8	181.2
			T2	602.3	1643.1	1552.5	8.70									
2	150.00	9692.70	T3	630.7	1811.7	1649.6	13.73	13.51	22.097	0.433	0.988	51.1	1.142	2421.7	2094.6	327.1
			T4	882.9	2126.9	1961.6	13.29									
3	250.00	9881.60	T5	638.7	2081.4	1849.7	16.06	15.58	26.104	0.362	1.039	72.2	1.231	2610.6	2204.0	406.6
			T6	632.4	1822.6	1643.0	15.09									
4	350.00	9971.00	T7	882.2	2349.9	2095.4	17.34	17.31	29.630	0.344	1.053	86.1	1.273	2700.0	2232.5	467.5
			T8	637.9	1868.8	1656.0	17.29									
5	450.00	9996.20	T9	654.3	2013.2	1746.5	19.63	19.73	34.780	0.372	1.031	93.5	1.285	2725.2	2187.5	537.7
			T10	639.6	1999.4	1729.7	19.83									
6	550.00	9980.00	T11	885.0	2251.5	1931.6	23.41	22.17	40.311	0.423	0.994	95.2	1.277	2709.0	2108.4	600.6
			T12	883.5	2181.9	1910.1	20.93									
7																
8																
9																
10																

Note: The example above uses two drying trays for each test.

Table 1.5.5 Specifications and tolerances for Proctor/Fagerberg cylindrical mould and hammer

Parameter	Units	Dimension	Tolerance
Hammer mass	g	337.5	± 2
Hammer diameter	mm	75	± 0.2
Drop height	mm	150	± 2
Tube ID	mm	78	± 0.2
Tube OD	mm	82	± 0.2
Tube wall thickness	mm	2	± 0.2
Tube clearance	mm	1.5	± 0.2
Mould inner diameter	mm	150	± 0.5
Mould inner height	mm	120	± 1
Mould inner volume	cm ³	2121	± 18
Removable extension piece height	mm	75	± 1
Depth of recess into base to seat	mm	1	± 0.2
Gap between mould and base	mm	≤ 0.1	
Gap between mould and extension piece	mm		(0 to + 0.1)
Clearance between mould and hammer	mm	≤ 6	

APPENDIX 3

Properties of solid bulk cargoes

1 Non-cohesive cargoes

1.1 The following cargoes are non-cohesive when dry:

194 In the list, add the following new entries in alphabetical order:

"MONOAMMONIUM PHOSPHATE (M.A.P.), MINERAL ENRICHED COATING"
 "MONOCALCIUMPHOSPHATE (MCP)"
 "OLIVINE SAND"
 "OLIVINE GRANULAR AND GRAVEL AGGREGATE PRODUCTS"
 "SAND, MINERAL CONCENTRATE, RADIOACTIVE MATERIAL, LOW SPECIFIC ACTIVITY (LSA-I) UN 2912"
 "SUGARCANE BIOMASS PELLETS"
 "SYNTHETIC SILICON DIOXIDE"

APPENDIX 4

INDEX

195 In the entry for "ILMENITE SAND", in the column of "Group", delete the words "or C".

196 Insert the following new entries in alphabetical order:

Material	Group	References
Beach iron	C	see IRON SMELTING BY-PRODUCTS
Bottom ash	A and B	see CLINKER ASH
Flat iron	C	see IRON SMELTING BY-PRODUCTS
Flint flat glass cullet	C	see GLASS CULLET
FOAM GLASS GRAVEL	C	
Granulated iron	C	see IRON SMELTING BY-PRODUCTS
K1-K3 bears	C	see IRON SMELTING BY-PRODUCTS
Iron pan edges	C	see IRON SMELTING BY-PRODUCTS
Iron skulls	C	see IRON SMELTING BY-PRODUCTS
IRON SMELTING BY-PRODUCTS	C	
METAL SULPHIDE CONCENTRATES, CORROSIVE UN 1759	A and B	
MONOAMMONIUM PHOSPHATE (M.A.P.), MINERAL ENRICHED COATING	B	
MONOCALCIUMPHOSPHATE (MCP)	A and B	
OLIVINE SAND	A	
OLIVINE GRANULAR AND GRAVEL AGGREGATE PRODUCTS	C	
Pig iron by-product	C	see IRON SMELTING BY-PRODUCTS
Plate iron	C	see IRON SMELTING BY-PRODUCTS
Pool iron	C	see IRON SMELTING BY-PRODUCTS
SAND, MINERAL CONCENTRATE, RADIOACTIVE MATERIAL, LOW SPECIFIC ACTIVITY (LSA-I) UN 2912	A and B	
Separation of iron	C	see IRON SMELTING BY-PRODUCTS
Silicon dross	C	see SILICON SLAG
Steel bears	C	see IRON SMELTING BY-PRODUCTS
SUGARCANE BIOMASS PELLETS	B	
SYNTHETIC CALCIUM FLUORIDE	A	
SYNTHETIC SILICON DIOXIDE	A	
TITANOMAGNETITE SAND	A	

11

APPENDIX 5

***Bulk Cargo Shipping Names in three languages
(English, Spanish and French)***

197 In Appendix 5 insert the following new entries in the corresponding alphabetical order:

"

ENGLISH	FRENCH	SPANISH
Beach iron	Fer de type grès dits "beach iron"	Hierro de tipo arenisco conocido como ("beach iron")
Bottom ash	Cendres résiduelles	Cenizas de fondo
Flat iron	Fer plat	Hierro plano
Flint flat glass cullet	Calcin de verre de silex plat	Desperdicios gruesos de vidrio flint
FOAM GLASS GRAVEL	GRANULAT DE VERRE CELLULAIRE	GRAVA DE VIDRIO CELULAR
Granulated iron	Granulats ferreux	Hierro granulado
K1-K3 bears	Pièces en forme d'ours des groupes K1-K3 dites "bears"	Cuescos K1 – K3
Iron pan edges	Fer en forme de poêles dits "Iron pan edges"	Hiero en forma de sartenes denominado ("Iron pan edges")
Iron skulls	Fer en forme de crânes ("iron skulls")	Hierro en forma de crâneos conocido como ("iron skulls")
IRON SMELTING BY-PRODUCTS	PRODUITS DE LA FUSION DU FER	PRODUCTOS DERIVADOS DE LA FUNDICIÓN DEL HIERRO
METAL SULPHIDE CONCENTRATES, CORROSIVE UN 1759	CONCENTRÉS DE SULFURES MÉTALLIQUES, CORROSIFS, ONU 1759	CONCENTRADOS DE SULFUROS METÁLICOS, CORROSIVOS (ONU 1759)
MONOAMMONIUM PHOSPHATE (M.A.P.), MINERAL ENRICHED COATING	MONOPHOSPHATE D'AMMONIUM, REVÊTEMENT ENRICHÉ EN MINÉRAUX	FOSFATO MONOAMÓNICO CON RECUBRIMIENTO DE MINERAL ENRIQUECIDO
MONOCALCIUMPHOSPHATE (MCP)	PHOSPHATE MONOCALCIQUE EN VRAC	FOSFATO MONOCÁLCICO (MCP)
OLIVINE SAND	SABLE D'OLIVINE	ARENA DE OLIVINO
OLIVINE GRANULAR AND GRAVEL AGGREGATE PRODUCTS	OLIVINE GRANULEUX ET PRODUITS D'AGREGATS DE GRAVIER	PRODUCTOS AGREGADOS GRANULARES Y DE GRAVA DE OLIVINO
Pig iron by-product	Sous-produits de la fonte brute	Productos derivados del hierro en lingotes
Plate iron	Plaques de fer	Placas de hierro
Pool iron	Résidus de hauts fourneaux	Residuos de altos hornos

ENGLISH	FRENCH	SPANISH
SAND, MINERAL CONCENTRATE, RADIOACTIVE MATERIAL, LOW SPECIFIC ACTIVITY (LSA-I) UN 2912	MATIÈRES RADIOACTIVES DE FAIBLE ACTIVITÉ SPÉCIFIQUE (LSA-I), ONU 2912, SABLES, CONCENTRÉS DE MINÉRAUX	ARENAS DE CONCENTRADOS DE MINERALES (MATERIAL RADIATIVO DE BAJA ACTIVIDAD ESPECÍFICA (BAE-I), ONU 2912)
Separation of iron	Résidus du processus de séparation	Residuos del proceso de separación
Steel bears	Pièces d'acier en forme d'ours dites "steel bears"	Cuescos de acero
SILICOMANGANESE (carbo-thermic)	SILICOMANGANÈSE (carbothermique)	SILICOMANGANESO (CARBOTÉRMICO)
SUGARCANE BIOMASS PELLETS	Biomasse de la canne à sucre en pellets	Pellets de biomasa de caña de azúcar
SYNTHETIC CALCIUM FLUORIDE	FLUORURE DE CALCIUM DE SYNTHÈSE	FLUORURO DE CALCIO SINTÉTICO
SYNTHETIC SILICON DIOXIDE	DIOXYDE DE SILICIUM DE SYNTHÈSE	DIÓXIDO DE SILICIO SINTÉTICO
TITANOMAGNETITE SAND	SABLE TITANOMAGNÉTITE	ARENA DE TITANOMAGNETITA
